

Kansas Agricultural Experiment Station Research Reports

Volume 0
Issue 1 *Cattleman's Day (1993-2014)*

Article 1542

1993

1993 Cattlemen's Day

Kansas Agricultural Experiment Station

Follow this and additional works at: <https://newprairiepress.org/kaesrr>

Recommended Citation

Kansas Agricultural Experiment Station (1993) "1993 Cattlemen's Day," *Kansas Agricultural Experiment Station Research Reports*: Vol. 0: Iss. 1. <https://doi.org/10.4148/2378-5977.7194>

This report is brought to you for free and open access by New Prairie Press. It has been accepted for inclusion in Kansas Agricultural Experiment Station Research Reports by an authorized administrator of New Prairie Press. Copyright 1993 the Author(s). Contents of this publication may be freely reproduced for educational purposes. All other rights reserved. Brand names appearing in this publication are for product identification purposes only. No endorsement is intended, nor is criticism implied of similar products not mentioned. K-State Research and Extension is an equal opportunity provider and employer.



1993

CATTLEMEN'S DAY



Report of Progress 678

Agricultural Experiment Station
Kansas State University, Manhattan
Marc A. Johnson, Director

CONTENTS

MEATS

Use of Visual Appearance as an Indicator of Degree of Doneness in Ground Beef Patties	1
Value-Added Beef Processing: Increasing the Value of Beef Shanks Using Baader™ Processing Technology	4
Can "Natural" Flavorings Enhance the Flavor of Low-Fat Ground Beef?	7

HARVESTED FORAGES

Evaluation of 24 Corn Hybrids for Silage Agronomic Performance under Both Irrigated and Dryland Conditions	10
Agronomic Performance and Silage Quality Traits of Forage Sorghum Hybrids in 1992	13
Whole-Plant Corn, Forage Sorghum, and Grain Sorghum Silages for Growing Cattle	16
Effects of Hybrid, Growing Condition, Storage Time, and Pioneer 1174® Silage Inoculant on Agronomic Performance and Nutritive Value of Whole-Plant Corn and Grain Sorghum Silages	19
Effect of Bacterial Inoculants on the Preservation of Alfalfa and Whole-Plant Corn Silages	24
Rate and Extent of Losses from Top Spoilage in Alfalfa Silages Stored in Bunker Silos	26
A Laboratory System for Modeling Hay Storage	31
Comparison of Conventional and Laboratory-Scale Alfalfa Hay Bales in Small Haystacks	34
Storage Losses in Net-Wrapped, Large, Round Bales of Alfalfa Hay	39
Preservation of Alfalfa Hay with a Microbial Inoculant	41
Summer Annual Forages in South Central Kansas	43
Large Round Bale Hay Wastage by Various Feeding Methods	46

RANGE AND GRAZING STUDIES

Effect of Protein Concentration in Supplements and Frequency of Supplementation on the Performance of Beef Cows Grazing Dormant Bluestem Range	49
Influence of Frequency of Supplementation and Protein Concentration in Supplements on Digestion Characteristics of Beef Steers Offered Wheat Straw	52
Effect of Level of Supplemental Alfalfa and Its Method of Processing on Intake and Utilization of Wheat Straw	55
Influence of Method of Processing Supplemental Alfalfa on Intake and Utilization of Dormant, Bluestem-Range Forage by Beef Steers	57

Growth and Reproductive Characteristics in Heifers Fed Endophyte-Infected Tall Fescue and Oxytetracycline	59
Endophyte-Infected, Tall Fescue Hay Utilization by Exercised, Yearling Horses	62
Pasture and Subsequent Feedlot Performance by Beef Cattle Grazing <i>Acremonium Coenophialum</i> -Infected Tall Fescue and Offered Different Levels of Ground Grain Sorghum	64
Effect on Summer Stocker Gains when Native Grass Pastures Were either Grazed Short during the Dormant Season or Burned in April	68

BREEDING AND GENETICS

Relationship between Expected Progeny Differences (EPD) and Performance of Angus and Simmental Bulls in Central Bull Tests	70
Ultrasound-Measured Ribeye Area EPD for Brangus Cattle	72
Factors Influencing the Price Paid for Bulls at Central Test Stations in Kansas from 1988-1992	75
The Relationships of Color to Performance and Carcass Traits in Cattle	78

PHYSIOLOGY

Factors Affecting Pregnancy Rates and Calving Difficulty in Commercial Beef Heifers	80
How Does Cow-Calf Association Inhibit the Onset of Estrous Cycles after Calving?	83
Use of Cystorelin® and Artificial Insemination in Repeat-Breeding Beef Heifers after Estrous Synchronization	86
Reproductive Performance of Yearling Beef Heifers after Estradiol Benzoate and Estrous Synchronization	88
Progesterone Concentrations, Estrous Response, and Fertility in Beef Heifers after Estrous Synchronization Using Melengestrol Acetate® and Prostaglandin F ₂	90
Luteinizing Hormone Release and Plasma Metabolites in Mature, Ovariectomized Beef Cows Fed Various Lipid Diets	93
Effect of Molybdenum/Sulfur-Induced Copper Deficiency upon Enzyme Levels and Reproduction in Heifers	97

NUTRITION

Effect of Density of Steam Flaked Milo on Animal Performance, Mill Production Rate, and Subacute Acidosis	99
Effect of Physical Form and Level of Alfalfa in Corn-Based Diets on Performance of Finishing Steers	102
Utilization of Dried Bakery Product by Finishing Beef Steers	105

Effect of Diet Energy Content and Level of Restriction on Performance, Nutrient Digestibility, and Puberty in Replacement Beef Heifers	107
Effect of Supplemental Fat and Thermal Stress on Nitrogen and Energy Metabolism of Finishing Heifers	109
Protein Supplementation of Ammoniated Wheat Straw: Effect on Intake and Digestion in Beef Steers	112
Protein Supplementation of Ammoniated Wheat Straw: Effect on Performance of Beef Cows	114
Gastrointestinal Thiaminase vs. Ration Changes	117

PRODUCTION AND FIELD STUDIES

Factors Affecting Cattle Finishing Profitability	120
Factors Affecting Cost of Gain of Feedlot Steers	123
Factors that Influence Number of Bids on Finished Cattle	126
Results of a Production Analysis Survey of Cow Herds in Kansas	128
Implant Comparisons in Feedlot Steers and Heifers	132
Comparison of Synovex-S® and Two Levels of Revalor-S® in Heavy-Weight Holstein Steers	135
Sequential Implant Strategies with Synovex-S® and Trenbolone Acetate-Containing Implants in Calf-Fed Holstein Steers	137
Antimicrobial Resistance among Important Bovine Pathogens Isolated at the KSU Veterinary Diagnostic Laboratory over Two and a Half Years	140
Inflammatory Response of Feedlot Cattle to Clostridial Vaccination: A Comparison of 7-Way Bacterin-Toxoid and C&D Toxoid	142
Effect of Zinpro 100® in a Mineral Mixture on Gain and Incidence of Footrot in Steers Grazing Native Grass Pastures	145
Effect of Mass Medication on the Health and Gain of Calves in Grass Paddocks or Feedlot Pens	147
Management of Stable Flies in Cattle Feedlots with Releases of Parasitic Wasps	149

BIOLOGICAL VARIABILITY AND STATISTICAL EVALUATION OF DATA	152
WEATHER DATA, 1991-1992	153
ACKNOWLEDGEMENTS	154

Contribution No. 93-318-S from the Kansas Agricultural Experiment Station.

USE OF VISUAL APPEARANCE AS AN INDICATOR OF DEGREE OF DONENESS IN GROUND BEEF PATTIES

*K. E. Warren, M. C. Hunt, M. A. Hague,
D. H. Kropf, and S. L. Stroda*

Summary

Outbreaks of food-borne illness have emphasized the need for proper cooking of ground beef patties. Because of difficulties in measuring internal temperature of ground beef patties, visual indicators usually are used to estimate degree of doneness. As internal temperature increases from 130 to 170°F, the internal appearance is expected to change from very red to brown and juice color from red to clear. Based on ground beef patties from three sources, we found that internal color over-estimated internal temperature. Expressible juice decreased in redness as internal temperature increased but did not run clear even at temperatures over 160°F. Regardless, expressible juice color was a better indicator of degree of doneness than internal color.

(Key Words: Ground Beef, Color, Cookery, End-Point Temperature, Safety.)

Introduction

The need for thorough cooking of ground beef patties has been identified by USDA as a food safety concern, since cases of food-borne illness have been linked to undercooked ground beef. Individuals at highest risk are the very young, the elderly, and the immunocompromised. Most outbreaks have occurred in smaller food establishments and in homes, likely due to difficulty in monitoring the actual degree of doneness. Large establishments have more carefully controlled cooking procedures to assure that specified end-point temperatures are reached. Ground beef patty shape makes it difficult to measure end-point temperature. Therefore, visual indicators are commonly used. USDA Food Safety and

Inspection Service (USDA-FSIS) developed the following recommendation to assure heating to 160°F. *"Heat all meat patties until they are hot, steaming, and juices run clear. The center of the patty should be grayish-brown with no evidence of pink color."*

As end-point temperature increases, cooked color develops, giving a product the appearance of doneness. However, prior work has shown that the typical development pattern of cooked color does not hold true for all patties. Ground beef patties from high pH raw material (pH > 5.8) have been called 'hard to cook' and tend to remain red at temperatures normally associated with a done appearance. Prior work at Kansas State has shown that patties from D and E maturity cattle (72 months and older), with a normal pH, appear well-done at internal temperatures lower than normal. Therefore, our objective was to determine the effect of several raw material sources and end-point temperatures on internal and expressible juice color of ground beef patties.

Experimental Procedures

We used three raw material sources: 10 knuckles from A-maturity animals, 10 knuckles from E-maturity Holstein cows, and 5 samples of import trim (approximately 15% fat) from Australia and New Zealand. All raw materials were within the pH range of 5.4 to 5.8 (normal). Knuckles were individually coarsely ground through a 1/4 in. plate, formulated to 15% fat, and finely ground through a 1/8 in. plate. Import trim was handled in a similar manner; however, no additional fat was added. Patties (0.25 lb) were formed, vacuum packaged, and frozen

until cooking. Thawed patties (38.3 °F) were cooked on an electric griddle (325 °F), and internal temperature was monitored using a thermocouple probe. Patties were cooked to 131, 140, 150, 160, or 170 °F internally. Patty internal color and expressible juice color were evaluated visually using a descriptive scale and an instrumental measure of redness.

Results and Discussion

Although visual color scores became less red ($P < .05$) as temperature increased (Figure 1), the change in color from 131 to 170 °F was not as pronounced as expected. At 131 °F, the patties were expected to look very red and undercooked. However, they were actually slightly pink or essentially tan, both characteristics of a medium degree of doneness. Although visual scores became less red ($P < .05$) with increasing temperature from 131 to 160 °F, internal appearance was more brown than expected. Instrumental evaluation supports the visual appraisal (Figure 2); the patties were already brown at low temperatures. Visually, expressible juice (Figure 1) changed from a dark dull red at

131 °F to a pinkish tan at 170 °F, and that was confirmed by instrumental measures (Figure 2). However, cooking to 170 °F did not produce clear juices, the endpoint dictated by USDA-FSIS.

The internal color of the three raw material sources (Table 1) did not differ ($P > .05$) in visual score, and although significant, differences in instrumental values were small. By instrumental measurement, expressible juice from A-maturity patties was redder than juice from import trim ($P < .05$). Expressible juice from E-maturity patties was intermediate and did not differ ($P > .05$) from juices from A-maturity or import trim.

Expressible juice may be a more reliable indicator of end-point temperature of a ground beef patty than internal patty color. However, juices were not clear at internal temperatures exceeding 160 °F, the USDA-FSIS recommended temperature. Therefore, expressible juice may be more accurately described as lacking redness rather than being clear. Other factors, such as storage time and handling as well as raw material source, may alter cooked color development and should be studied.

Table 1. Raw Material Effects on Instrumental and Visual Measurements of Internal and Expressible Juice Color of Cooked Ground Beef Patties

Color Measurement ^w	A-maturity	E-maturity	Import trim
INTERNAL COLOR			
Visual ^x	3.5	3.4	3.6
Instrumental ^y	52.3 ^a	52.8 ^a	54.9 ^b
EXPRESSIBLE JUICE			
Visual ^z	3.0	3.2	3.4
Instrumental ^y	34.2 ^a	38.3 ^{ab}	46.9 ^b

^{ab}Means within a row without a common superscript letter are different ($P < .05$).

^wMeans averaged across the five end-point temperatures.

^xColor scale: 1 = pink; 2 = moderately pink; 3 = slightly pink; and 4 = brown.

^yHue angle: $HA = \tan^{-1}(b/a)$. The larger the number the less red the color.

^zColor scale: 1 = dark, dull red; 2 = red; 3 = pink; 4 = pinkish red; and 5 = yellow, no pink.

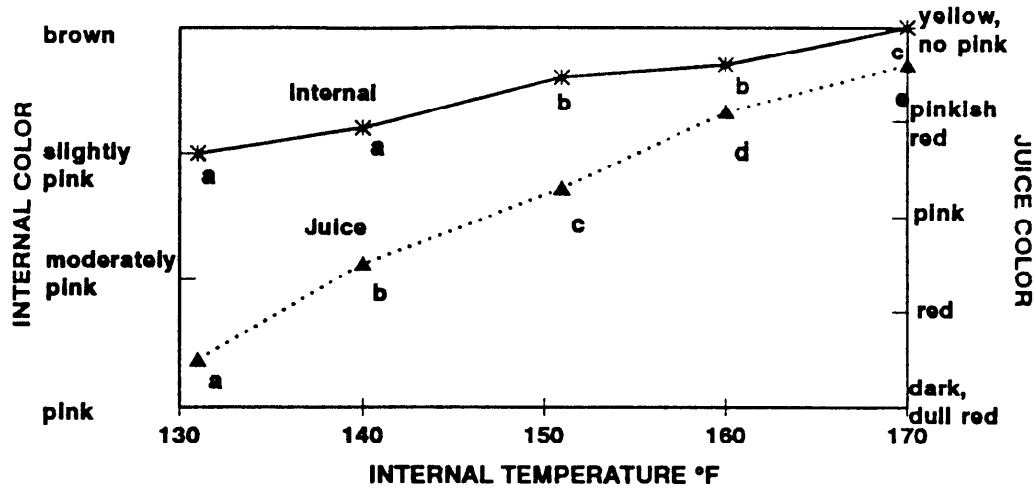

Figure 1. Visual Appraisal of Internal Color and Expressible Juice Color of Ground Beef Patties Cooked to Five Internal Temperatures. Within a Trait, Internal Temperatures without a Common Superscript Letter Are Different ($P < .05$).

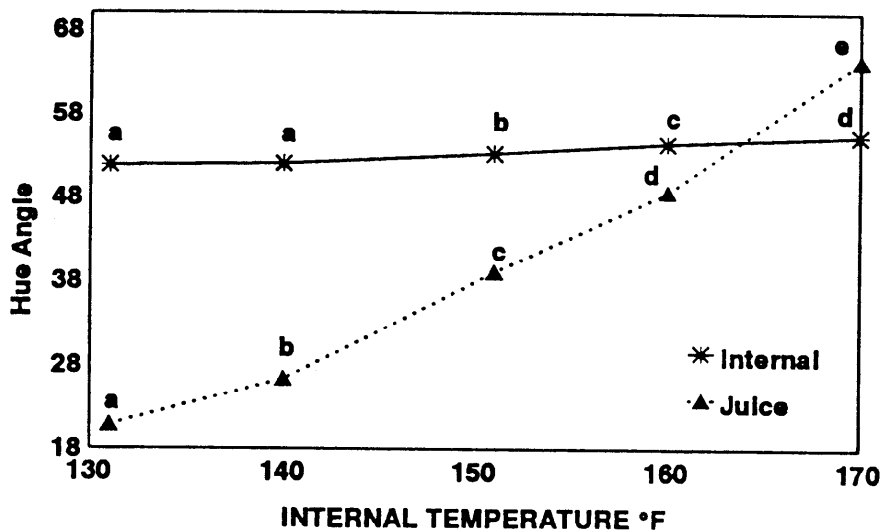

Figure 2. Instrumental Measure of Redness, for Internal Color and Expressible Juice Color of Ground Beef Patties Cooked to Five Internal Temperatures. The Larger the Number, the Less Red the Color. Within a Trait, Internal Temperatures without a Common Superscript Letter Are Different ($P < .05$).

VALUE-ADDED BEEF PROCESSING: INCREASING THE VALUE OF BEEF SHANKS USING BAADER™ PROCESSING TECHNOLOGY

R. E. Campbell and M. C. Hunt

Summary

Using a Baader™ desinewing machine on beef shanks can increase the value of a beef carcass by \$1 to \$5 by improving palatability and texture and reducing fat. By varying belt pressure and drum opening size and passing shanks twice through the desinewer, we obtained commercially acceptable yields. Maximum lean yield was 93% of the shank using 5 mm drum holes for both passes. With 3 mm drum holes, very lean (produced on the first pass. Using desinewed lean and flaking the sinew with an Urschel Commitrol®, we produced low-fat (10%) ground beef patties. Patties from desinewed lean alone and/or desinewed lean with flaked sinew reincorporated were more acceptable ($P < .05$) and had fewer noticeable connective tissue particles than patties made from unprocessed ground shank.

(Key Words: Beef, Shanks, Sinew, Collagen Low-fat.)

Introduction

Although beef shanks are a major source of lean manufacturing beef, their high connective tissue content prevents use as the sole lean source in many products. Baader desinewing removes the connective tissue and eliminates this problem. The desinewed lean alone has added value and can be used in many products. However, processing the sinew can modify it enough for re-incorporation at natural proportions into the desinewed lean, adding \$1 to \$3 to the value of a beef carcass.

Another benefit of Baader technology is that it can separate lean and fat. By varying

the belt pressure and drum hole size, 50-55% of the shank can be recovered at < 5% fat. The rest of the shank can still be used in a variety of products. This aspect of the process may add \$1 to 2 to the value of a beef carcass.

Experimental Procedures

Our eight treatments are listed in Table 1. Beef patties formulated to contain 5, 10, or 20% fat were made from beef shanks or beef round. Each treatment was replicated three times. In three treatments, sinew was reincorporated into the patty mix after flaking frozen sinew through an Urschel Commitrol either once or twice. Yields and compositions of the various manufacturing streams are shown in Table 2.

Results and Discussion

Yields of usable lean were over 92% after two passes through the desinewer. Sinew yield was 6.5 to 7% (Table 2), similar to yields achieved by commercial packers using this technology. The pH of shank meat (6.07) was higher than that of round muscles (5.79). Higher pH improves water-holding capacity in manufacturing meat and may explain the higher juiciness scores of patties made from shank (Table 3).

Baader technology can reduce fat content in first pass lean, while desinewing at the same time. Fat in first pass lean ranged from 4 to 8% depending on drum hole size and belt pressure. Collagen was 27 to 47% less in first pass lean than in whole ground shank (WGS), depending on drum hole size and pressure. Smaller drum holes reduced fat and collagen

more than larger holes, but also reduced first pass lean yields (Table 2).

Patty composition and consumer sensory panel results are shown in Table 3. Patties made from shank meat had higher pH values than those made from ground round. Measured fat was within 1.5% of target levels for each treatment. Collagen content was greater in patties made from whole ground shank (WGS) than in control patties (10C and 20C) made from round muscles.

One purpose of this research was to determine if the recovered sinew could be modified and reincorporated with the desinewed lean as low-fat ground beef. Panelists found fewer detectable connective tissue particles in treatments with (5/5S) and

without (5/5NS) flaked sinew compared to WGS and the control treatments (Table 3). Higher juiciness scores for shank-containing patties may be explained by either improved water binding by either collagen or higher pH. As expected, desinewing reduced collagen in those treatments where processed sinew was not reincorporated (5/5NS and 3S). Adding of 7% flaked sinew to the patty mix resulted in collagen levels similar to those of WGS patties (Table 3).

These data need to be confirmed by a larger scale test. However, sinew modification and reincorporation appear promising as ways to improve the value of beef. The potential additional return is \$1 to \$5 per carcass, depending on how a processor utilizes the technology and how much the sensory quality of beef shanks is improved.

Table 1. Treatments of Desinewed Shanks

Treatment	Lean raw material	Baader used	Drum 1st pass	Drum 2nd pass	Target fat %	Added sinew %
20C	Round	No	N/A	N/A	20	0
10C	Round	No	N/A	N/A	10	0
WGS	Shanks	No	N/A	N/A	10	0
5/5NS	Shanks	Yes	5 mm	5 mm	10	0
5/5 S	Shanks	Yes	5 mm	5 mm	10	7
3/5 S	Shanks	Yes	3 mm	5 mm	10	7
5/5S-F2x (flaked twice)	Shanks	Yes	5 mm	5 mm	10	7
3S	Shanks	Yes	3 mm	N/A	5	7

Table 2. Means for Yields, Composition, and pH of Beef Shank, Knuckle, and Fat Tissues

Tissue	Yield, %	pH	Composition, %		
			Moisture	Fat	Collagen, mg/g
Desinewed shank 5mm drum holes, 2 passes					
1st-pass lean	72.8 ^a	5.99	72.1 ^b	7.0 ^{de}	10.5 ^c
2nd-pass lean	19.6 ^d	6.11	67.5 ^c	13.6 ^{bc}	13.8 ^b
2nd-pass sinew	6.7 ^e	5.72	67.1 ^c	14.1 ^{bc}	29.5 ^a
Desinewed shank 3 mm, then 5 mm drum holes					
1st-pass lean	66.1 ^b	6.15	73.1 ^b	5.3 ^e	7.6 ^d
2nd-pass lean	25.1 ^c	6.12	63.6 ^c	18.8 ^a	27.9 ^a
2nd-pass sinew	6.8 ^e	5.65	68.0 ^c	14.3 ^b	29.3 ^a
Whole shank	---	6.07	69.5 ^c	10.3 ^{cd}	14.5 ^b
Round muscles	---	5.79	76.5 ^a	2.5 ^f	5.3 ^d
Fat	---	5.57	14.1 ^d	82.0 ^a	---

^{a-f}Means in a column with a different superscript letter are different ($P < .05$).

Table 3. Means for pH, Tissue Composition, and Consumer Panel Scores of Ground Beef Made from Desinewed Shank

Treatment ^d	pH	Composition, %			Consumer panel scores ^e		
		Moisture	Fat	Collagen, mg/g	Particle detection	Juiciness	Overall acceptability
20C	5.80 ^b	63.4 ^c	19.0 ^a	5.2 ^b	3.1 ^{bc}	4.2 ^b	4.6 ^b
10C	5.81 ^b	70.8 ^b	9.4 ^b	5.3 ^b	2.7 ^c	3.9 ^b	4.3 ^b
WGS	6.08 ^a	69.6 ^b	10.4 ^b	14.5 ^a	4.5 ^a	6.1 ^a	6.0 ^a
5/5NS	6.02 ^a	69.4 ^b	11.2 ^b	6.1 ^b	4.0 ^a	5.5 ^a	6.2 ^a
5/5S	6.06 ^a	68.4 ^b	11.5 ^b	14.8 ^a	3.9 ^{ab}	5.5 ^a	6.3 ^a
3/5S	6.12 ^a	68.7 ^b	11.0 ^b	14.3 ^a	---	---	---
5/5S-F2x	6.04 ^a	68.7 ^b	11.3 ^b	12.3 ^a	---	---	---
3S	6.07 ^a	72.0 ^a	7.0 ^c	9.5 ^{ab}	---	---	---

^{abc}Means in a column with a different superscript letter are different ($P < .05$).

^d20C and 10C = 20 and 10% fat control ground round; WGS = whole ground shank; 3 and 5 = 3 or 5 mm drum holes; NS = no sinew added; S = 7% flaked sinew added to desinewed shank; F2x = sinew flaked twice and added to desinewed shank.

^eHigher scores indicate more particles or juicier or more acceptable product.

CAN "NATURAL" FLAVORINGS ENHANCE THE FLAVOR OF LOW-FAT GROUND BEEF?

*C. F. Carmack, C. L. Kastner, M. C. Hunt,
D. H. Kropf, and J. R. Schwenke¹*

Summary

Natural flavorings were evaluated for use in low-fat ground beef, which frequently lacks flavor intensity. Three lean sources, A-maturity (young), E-maturity (mature cow), and imported (cow) beef round muscles, were used to formulate 7% and 25% fat ground beef. A-maturity fat was added to adjust fat levels. Controls (no added flavors) were prepared for each lean source. No additives were used in 25% fat controls, but 7% fat controls contained water (10%), carrageenan (.5%), and encapsulated salt (.38%). Four "natural" flavorings; Dried Cream Extract (DCE, Cumberland Packing Co., Inc.); Natural Prime Beef Base WONF #224545 and #224546 (224545, 224546, Tastemaker); and Hydrolyzed Vegetable Protein (HVP, A.C. Legg, Inc.) were added to 7% fat ground beef at recommended levels. A- and E-maturity domestic 25% fat controls were scored higher ($P < .05$) for ground beef flavor intensity and lower ($P < .05$) for off-flavors than 25% fat patties from imported beef. The 7% fat patties from imported lean had greater ($P < .05$) beef flavor intensity and reduced off-flavors ($P < .05$) when flavorings 224545, 224546, and HVP were added. These flavorings also enhanced the beef flavor intensity of low-fat patties from A-maturity lean to a level similar to that of the 25% fat control. Beef flavor intensity after a 60-min holding period was not enhanced by the natural flavorings, except when 224546 was added to E-maturity domestic lean. Therefore, the "natural" flavorings were most beneficial with imported lean.

(Key Words: Low-fat, Ground Beef, Flavor, Juiciness, Lean Source.)

Introduction

Ground beef, which accounts for 44% of beef consumption in the United States, is popular in many households for its low cost and convenience. Consumers select ground beef based on color and leanness.

Developing products that customers perceive as "healthy" is not as simple as just removing the fat, because as fat is reduced, palatability is compromised. Because consumers often view added ingredients as "unnatural" or "unhealthy", this study was designed to evaluate the use of "natural" flavorings to enhance flavor in 7% fat ground beef.

Experimental Procedures

Patty Production

A-maturity, E-maturity, and imported beef round muscles and A-maturity beef fat were thawed at 36°F for 24 hr before grinding through a 1/2" plate. Lean and fat were mixed to achieve desired fat levels. For 7% fat controls, carrageenan (.5%) and encapsulated salt (.38%) were incorporated by mixing in a bowl mixer for 1 min. Water (10%) was then added, and the product was mixed for 1 min. The 25% fat controls had no additives. Natural flavorings were mixed with appropriate batches at the suppliers' recommended levels. These flavorings had been screened and selected from 15 candidates by a five-member

¹Department of Statistics.

professional taste panel as having the most potential based on ground beef flavor intensity and absence of off-flavors.

Batches were ground through a 1/8" plate. Patties (.25 lb) were formed using a manual patty press and crust-frozen at -40°F for 1 hr before vacuum packaging and storing at -40°F.

Sample Preparation

Patties were thawed at 36°F for 24 hr and cooked on preheated (302°F) electric griddles. Patties were turned every 30 sec until reaching a final internal temperature (hypodermic probe thermocouple) of 160°F. Cooked patties were either evaluated immediately or held in double boilers (147°F) for 60 min before evaluation. Immediately prior to evaluation, patties were cut into six equal pie-shaped portions.

Panel Training

The same five-member professional panel that screened the flavorings was trained in open-discussion sessions to evaluate beef flavor intensity, juiciness, mouth coating, and off-flavors. Patties with and without 60 min holding time were used for training, with the A-maturity, 25% fat control used to reference "typical" ground beef.

Sensory Evaluation

Panelists were randomly served ground beef samples in individual booths under red lighting. Nine samples were served during each of two sessions per day for a 6-day period. Responses were marked on a 10-point scale where 1 = extremely bland, no

off-flavors, dry, or no mouth coating; 5 = moderately intense beef flavor or off-flavor, moderate juiciness and mouth coating; 10 = extremely intense beef flavor or off-flavor, extreme juiciness or mouth coating. Water, unsalted crackers, and apple slices were provided to clear the palate between samples.

Results and Discussion

Evaluated Immediately

A- and E-maturity 25% fat controls from domestic beef were scored higher ($P < .05$) for ground beef flavor intensity and lower ($P < .05$) for off-flavors than the imported counterpart (Table 1). Adding "natural" flavorings 224545, 224546, and HVP to 7% fat patties from imported lean increased ($P < .05$) beef flavor and reduced ($P < .05$) off-flavors. These flavorings also increased the beef flavor intensity for A-maturity domestic lean to a level similar to that of 25% fat control. Flavorings did not affect juiciness or mouth coating for the imported product.

Held for 60 Min

For mass feeding, cooked patties are frequently held before serving. Except for flavoring 224546 for the E-maturity domestic lean source, beef flavor intensity was not enhanced by the natural flavorings (Table 2). Flavoring 224545 frequently resulted in more intense off-flavors when patties were held 60 min.

"Natural" flavorings may enhance ground beef flavor in low-fat patties, particularly if imported lean is used in the formulation. Because the positive effect of "natural" flavoring 224546 carried through the 60-min holding period, this flavoring may help alleviate flavor problems associated with prolonged holding after cooking.

Table 1. Treatment Means for Sensory Evaluation of Ground Beef Patties Containing "Natural" Flavorings and Evaluated Immediately

Lean source additive	Fat, %	Beef flavor intensity	Juiciness	Mouth coating	Off-flavor
<u>A-maturity domestic</u>					
H ₂ O, Salt, Carrageenan	7	6.3 ^{cd}	4.8 ^{efg}	2.7 ^{bcd}	2.1 ^{ef}
DCE	7	6.3 ^{cd}	5.7 ^a	2.9 ^{ab}	2.3 ^{ef}
224545	7	6.3 ^{bcd}	5.1 ^{bcde}	2.7 ^{bc}	3.2 ^{bc}
224546	7	6.5 ^{bcd}	5.6 ^{ab}	2.8 ^{abc}	2.6 ^{de}
HVP	7	6.5 ^{bcd}	5.5 ^{abc}	2.7 ^{bc}	2.1 ^{ef}
None	25	6.9 ^{ab}	4.4 ^g	2.6 ^{bcd}	1.3 ^h
<u>E-maturity domestic</u>					
H ₂ O, Salt, Carrageenan	7	6.7 ^{abc}	5.1 ^{bcde}	2.5 ^{cd}	1.9 ^{fgh}
DCE	7	6.7 ^{abc}	4.5 ^{fg}	2.7 ^{bcd}	1.5 ^{gh}
224545	7	6.3 ^{bcd}	5.9 ^a	2.9 ^{ab}	3.0 ^{cd}
224546	7	6.4 ^{bcd}	5.0 ^{cdef}	2.3 ^d	1.9 ^{fg}
HVP	7	6.4 ^{bcd}	5.4 ^{abcd}	2.7 ^{bcd}	2.3 ^{ef}
None	25	7.1 ^a	5.6 ^{ab}	3.1 ^a	1.3 ^h
<u>Import</u>					
H ₂ O, Salt, Carrageenan	7	4.6 ^f	4.7 ^{efg}	2.7 ^{bcd}	4.2 ^a
DCE	7	4.7 ^f	4.9 ^{defg}	2.7 ^{bc}	4.3 ^a
224545	7	5.5 ^e	5.0 ^{cdef}	2.7 ^{bcd}	3.6 ^{bc}
224546	7	5.4 ^e	4.8 ^{efg}	2.8 ^{abc}	3.6 ^b
HVP	7	5.5 ^e	4.6 ^{efg}	2.7 ^{bcd}	3.3 ^{bc}
None	25	6.1 ^d	4.4 ^{fg}	2.8 ^{ab}	2.3 ^{ef}

^{a-h}Means in the same column with a different superscript letter are different (P < .05).

Table 2. Treatment Means for Sensory Evaluation of Ground Beef Patties Containing "Natural" Flavorings and Held for 60 Min

Lean Source Additive	Fat, %	Beef flavor intensity	Juiciness	Mouth coating	Off-flavor
<u>A-maturity domestic</u>					
H ₂ O, Salt, Carrageenan	7	6.7 ^{ab}	4.0 ^{bcde}	2.8 ^{bc}	2.0 ^{fg}
DCE	7	6.7 ^{ab}	4.1 ^{abcd}	2.6 ^{bcd}	1.7 ^{fgh}
224545	7	6.4 ^{abc}	4.1 ^{abcd}	2.6 ^{bcd}	2.7 ^{de}
224546	7	6.5 ^{ab}	3.8 ^{bcdef}	2.2 ^{de}	2.1 ^{ef}
HVP	7	6.4 ^{abc}	3.4 ^{fg}	2.4 ^{bcde}	1.8 ^{fgh}
None	25	6.5 ^{ab}	4.3 ^{ab}	2.5 ^{bc}	1.3 ^h
<u>E-maturity domestic</u>					
H ₂ O, Salt, Carrageenan	7	6.2 ^{bcd}	3.4 ^{fg}	2.2 ^e	1.7 ^{fgh}
DCE	7	6.5 ^{ab}	4.3 ^{ab}	2.3 ^{cde}	1.6 ^{fgh}
224545	7	5.8 ^{cde}	3.8 ^{bcdef}	2.6 ^{bc}	2.7 ^d
224546	7	6.9 ^a	4.6 ^a	2.6 ^{ab}	1.8 ^{fgh}
HVP	7	6.7 ^{ab}	4.2 ^{ab}	2.6 ^{bc}	1.5 ^{fgh}
None	25	6.8 ^{ab}	4.2 ^{ab}	2.5 ^{bc}	1.4 ^{gh}
<u>Import</u>					
H ₂ O, Salt, Carrageenan	7	5.3 ^{ef}	3.8 ^{bcdef}	2.6 ^{bc}	3.6 ^{bc}
DCE	7	4.9 ^f	3.5 ^{defg}	2.4 ^{bcde}	3.8 ^{ab}
224545	7	4.9 ^f	3.5 ^{efg}	2.5 ^{bcd}	4.3 ^a
224546	7	5.1 ^f	3.6 ^{cdefg}	2.6 ^{bc}	3.9 ^{ab}
HVP	7	4.8 ^f	3.1 ^f	2.4 ^{bcde}	3.8 ^{ab}
None	25	5.7 ^{de}	4.1 ^{abc}	2.9 ^a	3.0 ^{cd}

^{a-h}Means in the same column with a different superscript letter are different (P < .05).

EVALUATION OF 24 CORN HYBRIDS FOR SILAGE AGRONOMIC PERFORMANCE UNDER BOTH IRRIGATED AND DRYLAND CONDITIONS¹

*R. N. Sonon, B. S. Dalke, M. A. Young, D. L. Holthaus,
D. R. Bonilla, L. Pfaff, J. E. Boyer, Jr.²,
B. E. Brent, and K. K. Bolsen*

Summary

In 1992, 24 corn hybrids were grown under both irrigated and dryland conditions and were harvested at 90% of the kernel milk line. Growing condition and hybrid significantly affected plant height and the number of days to the tasseling and silking stages. Most dryland hybrids had higher dry matter (DM) contents than irrigated hybrids, but all 24 hybrids had higher grain yields under irrigation. Growing condition and hybrid also significantly affected whole-plant DM and stover yields and percentages of cob and stover. The grain portion made the greatest contribution to the higher whole-plant silage yields for the irrigated hybrids compared to their dryland counterparts.

(Key Words: Corn, Hybrid, Silage, Yield.)

Introduction

Typically, corn hybrids grown for silage have been selected for their high grain yield potential and not necessarily for silage traits. However, in three previous KAES Reports of Progress (592, 623, and 651; pages 110, 62, and 110, respectively), we have shown that growing season (year), growing condition (irrigated vs. dryland), hybrid, and stage of maturity at harvest all affect whole-plant silage and grain yields and whole-plant DM contents. Therefore, our objective was to continue

measuring the agronomic traits important to silage production, using 24 corn hybrids grown under both irrigation and dryland in 1992.

Experimental Procedures

Twenty-four, high grain-yielding, corn hybrids, representing a range of season lengths and genetic diversity, were grown under both irrigated and dryland conditions in 1992 near the Kansas State University campus. The experiment was a split-plot design, with growing condition as the main plot and each hybrid assigned to subplots that were replicated three times. The hybrids were planted on May 18, in plots 33 ft long that contained six, 30-in. rows. Anhydrous ammonia (100 lb/acre) was applied preplant, Furadan 15G insecticide was applied in the furrows at planting, and Ramrod-atrazine (2 lb/acre) was applied as the preemergence herbicide 1 day after planting. Two weeks after seedling emergence, irrigated plots were thinned to about 26,000 and dryland plots, to about 17,000 plants per acre. All hybrids were harvested just before the black layer stage of maturity (approximately 90% milk line of kernel development). Agronomic data included days to tassel and silk, plant height, whole-plant DM percent and yield, and grain and stover yields. Shortly prior to harvest, each plot was trimmed to remove border effects. Whole-plant DM yield was deter-

¹Partial financial assistance was provided by Cargill Hybrid Seeds, Minneapolis, MN; ICI Seeds, West Des Moines, IA; and Pioneer Hi-Bred International, Inc., North American Seed Division, Johnston, IA.

²Department of Statistics.

mined from two inside rows, and grain and stover yields and plant part proportions were obtained from the other two inside rows.

Results and Discussion

Agronomic performance of the 24 corn hybrids is shown in Table 1. There were significant interactions between growing condition and hybrid for whole-plant DM content, grain yield, and percent grain. Growing condition and hybrid both significantly influenced the number of days to reach the tassel and silk stages (data not shown), and the average interval between these stages was 4 days for each growing condition. The irrigated hybrids averaged 5 inches taller than dryland hybrids.

Whole-plant DM content ranged from 30.0 to 42.1% (avg, 35.4%) for the irrigated and 34.1 to 44.8% (avg, 39.9%) for the dryland hybrids. All but two of the 24 hybrids (Pioneer 3417 and ICI 8513) had a lower DM content under irrigation than dryland. All hybrids grown under irrigation had higher grain yields than their dryland

counterparts (avg. 209.5 vs. 166.3 bu/acre). However, because the magnitude of the increase in grain yield from irrigation was not the same across all hybrids, significant interaction occurred between growing condition and hybrid. Five of the top six grain-producing hybrids under irrigation were from Pioneer (3245, 3377, 3379, 3394, and 3417), and three of those were also in the top six grain-producing hybrids under dryland (3245, 3377, and 3417).

Growing condition significantly affected whole-plant DM and stover yields. All 24 hybrids had higher whole-plant DM yields under irrigation than dryland (avg. 10.0 vs. 8.4 tons/acre). Twenty hybrids had their highest stover yield under irrigation.

The increase in whole-plant yields from irrigation was due largely to an increase in the grain portion. These results are consistent with previous studies and confirm the important contribution of grain yield to whole-plant silage yields.

Table 1. Effects of Hybrid and Growing Condition on Plant Height; Whole-plant Dry Matter Content; Whole-plant DM, Stover, and Grain Yields; and Plant Part Proportions of the 24 Corn Hybrids

Hybrid	Irrigated								Dryland								
	Plant height, inches	DM yield		Grain yield, bu/acre ¹	Plant part proportions			Plant height, inches	DM yield		Grain yield, bu/acre ¹	Plant part proportions					
		Whole-plant DM content, %	Whole-plant tons/acre		Stover	grain	stover		cob	Whole-plant DM content, %		Whole-plant tons/acre	Stover	grain	stover	cob	
<u>Cargill</u>									<u>% of the whole-plant DM</u>								
6227	93	37.9	9.0	3.4	213.5	56.6	37.2	6.2	91	40.4	8.1	3.5	168.5	50.1	43.7	6.2	
7697	109	35.0	9.8	3.9	215.2	53.4	38.9	7.7	101	38.5	8.7	4.1	164.1	45.2	47.6	7.3	
7877	109	33.3	10.1	4.4	214.5	50.9	43.4	5.7	103	42.6	8.6	4.1	165.9	46.3	47.6	6.2	
7997	101	39.0	10.4	5.0	202.3	46.4	47.6	6.0	103	44.8	7.7	3.1	169.4	53.3	39.4	7.3	
8427	97	35.9	10.5	4.9	200.6	45.7	46.9	7.4	91	36.0	8.9	4.6	152.6	41.2	51.4	7.4	
9027	113	35.2	10.3	5.4	179.9	41.7	52.5	5.8	112	41.2	9.0	4.7	158.2	42.1	52.3	5.7	
<u>DeKalb</u>									<u>% of the whole-plant DM</u>								
636	98	31.9	9.6	4.6	186.3	46.4	47.4	6.2	97	42.0	8.5	4.0	165.7	46.7	46.8	6.4	
646	102	35.3	9.8	4.5	192.6	47.4	46.2	6.4	101	40.6	8.2	3.4	178.2	51.8	41.2	7.0	
656	99	36.1	10.4	4.9	204.8	47.1	46.9	6.0	97	36.4	8.5	4.2	157.8	44.6	49.1	6.3	
671	108	38.2	10.4	4.4	217.9	50.4	42.3	7.4	94	44.7	7.9	3.3	169.6	51.9	40.9	7.2	
711	107	34.8	9.6	3.8	214.4	53.4	39.2	7.3	101	40.7	8.4	4.0	160.0	46.0	46.6	7.4	
715	105	37.0	10.2	4.2	217.2	51.1	41.5	7.4	98	42.5	8.2	3.6	164.2	47.9	44.1	8.0	
<u>Pioneer</u>									<u>% of the whole-plant DM</u>								
3245	103	36.0	10.3	3.9	240.3	56.0	37.6	6.4	95	44.8	7.9	3.1	176.8	53.5	38.8	7.7	
3377	108	37.7	10.5	4.4	221.3	51.0	41.5	7.5	100	39.3	8.9	3.8	182.4	49.1	42.9	8.0	
3379	104	34.9	10.0	4.1	219.1	52.6	40.8	6.6	98	36.9	9.0	4.2	172.3	45.9	46.9	7.2	
3389	106	30.0	9.2	4.3	173.8	45.5	47.3	7.2	101	34.1	7.9	3.7	151.1	45.9	46.2	7.9	
3394	101	33.2	9.9	3.5	237.0	57.4	35.0	7.7	99	36.4	7.7	3.0	170.4	53.5	37.9	8.6	
3417	95	42.1	10.2	3.9	230.8	54.3	38.1	7.6	87	40.7	8.1	3.3	172.7	51.3	40.6	8.1	
<u>ICI</u>									<u>% of the whole-plant DM</u>								
8260	103	35.2	9.7	3.8	217.2	53.4	39.3	7.4	96	43.5	7.7	3.3	159.2	49.6	42.2	8.2	
8272	96	33.3	9.8	4.5	197.5	48.2	46.0	5.7	90	40.9	8.6	4.3	159.3	44.5	49.7	5.7	
8310	97	34.3	10.5	5.0	202.0	46.1	47.4	6.4	95	40.0	8.6	4.1	164.2	45.5	47.8	6.7	
8315	110	33.1	10.2	4.7	205.3	48.1	45.9	6.0	107	38.4	9.1	4.7	160.4	42.1	51.9	6.0	
8326	103	35.0	10.3	4.7	206.5	48.0	45.2	6.8	100	35.6	8.4	3.5	173.9	49.7	42.0	8.2	
8513	98	36.3	10.2	4.4	218.1	51.1	43.1	5.8	94	35.3	8.7	4.0	174.3	47.9	45.7	6.4	
Mean	103	35.4	10.0	4.2	209.5	50.1	43.2	6.7	98	39.9	8.4	3.7	166.3	47.7	45.1	7.1	

¹Adjusted to 14.5% moisture.

AGRONOMIC PERFORMANCE AND SILAGE QUALITY TRAITS OF FORAGE SORGHUM HYBRIDS IN 1992¹

*M. A. Young, R. N. Sonon, B. S. Dalke,
D. L. Holthaus, D. R. Bonilla, L. Pfaff, and K. K. Bolsen*

Summary

Rainfall was much above and temperature much below normal during the 1992 growing season. Both whole-plant dry matter (DM) and grain yields were excellent for all 11 hybrids. The two short, mid-maturing, forage sorghums (Northrup King 300 and Golden Harvest H-45) had the highest silage and grain yields; the early-maturing (Cargill 200F) and male sterile (Golden Harvest H-1) forage sorghums and the grain sorghum (DeKalb DK 42Y) the lowest silage yields. A storm with high winds on October 7 and 8 caused severe lodging in all six mid- and late-maturing hybrids (earlier-maturing hybrids had already been harvested). The 10 forage sorghum hybrids differed significantly in three important silage quality traits—whole-plant DM, crude protein, and acid detergent fiber. Silage agronomic performance for four of the forage sorghums over 6 of the past 7 years is presented.

(Key Words: Forage Sorghum, Hybrid, Silage, Yield.)

Introduction

Forage sorghum has become an increasingly important silage crop for beef and dairy producers in the High Plains. In Kansas, almost 100,000 acres were harvested for silage in 1990, producing about 1,350,000 tons. In several earlier studies, we have shown that harvesting forage sorghums at the late-dough stage optimizes silage yields and nutritive values (KAES Report of Progress 623, page

65) and that the growing season has a tremendous effect on the agronomic traits of individual hybrids and varieties (KAES Report of Progress 568, page 12). The objective of this study was to continue to document the effects of hybrid and growing season on the agronomic performance and silage quality traits of forage sorghums.

Experimental Procedures

Ten forage sorghum hybrids were selected to represent a range of phenotypic characteristics and season lengths (Table 1). All were grown under dryland conditions near the Kansas State University campus. A grain sorghum hybrid (DeKalb 42Y) was included for comparison. The forage sorghum plots were planted on June 19, and each hybrid was randomly assigned to three replications. The grain sorghum was planted on June 8. The 6-row plots were in a Reading silt loam soil, and this was the first crop after a 5-year stand of alfalfa. No fertilizer was applied. Rows were 30 ft long with a 30-in. spacing, and plots were thinned to uniform stands of 34,800 plants per acre.

Hybrids were harvested at the late-dough stage of kernel maturity. The two outside rows in each plot were borders, and whole-plant DM yield was measured by harvesting the 2nd and 3rd rows with a precision chopper. All heads in the 4th and 5th rows were clipped for grain yield determination. A sample of the whole-plant material from each plot was analyzed for DM, crude protein (CP), and acid detergent fiber (ADF).

¹Partial financial assistance was provided by The J.C. Robinson Seed Co., Waterloo, Nebraska.

Table 1. Agronomic Performance and Quality Traits of the 10 Forage Sorghum Hybrids and the Grain Sorghum

Hybrid	Days to half bloom ¹	Plant height, inches ²	Harvest date	Whole-plant ³			DM yield, tons/acre	Grain yield, bu/acre ⁴
				DM, %	CP, %	ADF, %		
DeKalb DK 42Y								
grain sorghum	55	54 (0)	Sept. 24	34.5	8.8	28.2	6.03	108
Cargill 200F	62	108 (2)	Sept. 24	36.9	7.4	37.0	6.95	105
DeKalb FS-5	65	115 (0)	Sept. 28	28.9	7.7	31.9	7.79	96
Pioneer 947	72	110 (0)	Oct. 5	37.5	7.5	31.7	8.10	133
Northrup King 300	76	72 (67)	Oct. 15	32.7	7.2	35.0	8.85	173
DeKalb FS-25E	81	125 (88)	Oct. 20	27.3	6.3	37.5	8.03	98
Golden Harvest								
H-1	---	107 (0)	Sept. 25	26.0	7.2	30.4	6.65	---
EX-1216	68	113 (13)	Sept. 28	26.5	7.1	31.4	7.77	102
H-45	76	71 (57)	Oct. 15	32.7	7.0	33.2	9.26	140
H-2	80	111 (82)	Oct. 20	29.9	6.4	38.3	8.72	133
H-68	82	125 (90)	Oct. 20	32.2	6.3	33.4	8.18	125
Mean ⁵	74	106 (40)	Oct. 8	31.1	7.0	34.0	8.03	123
LSD (P < .05) ⁶	2.4	6 (34)	---	2.1	.3	1.3	2.1	21

¹Golden Harvest H-1 is a male sterile. Paper bags were placed over the emerging heads to prevent grain development in the two harvested rows. ²Percent lodging on the day of harvest is shown in parentheses. ³Crude protein (CP) and acid detergent fiber (ADF) are expressed on a DM basis. ⁴Adjusted to 14.5% moisture. ⁵Mean values include only the 10 forage sorghum hybrids. ⁶The LSD (least significant difference) is valid only within a column.

Results and Discussion

Agronomic performance of the 11 hybrids is presented in Table 1. Days to half bloom for the 10 forage sorghums ranged from 62 to 82. The late planting date and the cool, wet weather in July, August, and September delayed the harvest for all hybrids. Plant heights were relatively tall and, as expected, two of the late-maturing forage sorghums (DeKalb FS-25E and Golden Harvest H-68) were the tallest (P < .05). The two dual-

purpose hybrids (Northrup King 300 and Golden Harvest H-45) were the shortest (P < .05).

Five of the 10 forage sorghums were at least 32% in whole-plant DM at the late-dough stage harvest. This is important because hybrids with less than 30% DM are less efficiently preserved as silage and can produce large amounts of effluent during early fermentation.

The two short, mid-maturing, forage sorghums (Northrup King 300 and Golden Harvest H-45) had the highest silage and grain yields; the early-maturing (Cargill 200F) and male sterile (Golden Harvest H-1) forage sorghums and the grain sorghum had the lowest silage yields. A storm with high winds on October 7 and 8 caused severe lodging in all six mid- and late-maturing hybrids. Earlier-maturing hybrids had already been harvested.

As expected, the grain sorghum (DeKalb DK 42Y) had the highest CP (8.8%) and lowest ADF (28.2%). Among the 10 forage sorghums, CP ranged from 6.3 to 7.5% and ADF, from 30.4 to 38.3 percent. Also, there were no significant correlations between the three silage quality traits (whole-plant DM, CP, and ADF) and days to half bloom, plant height, and whole-plant DM and grain yields.

In 6 of the past 7 years (excluding 1991), a selected number of forage sorghum cultivars (hybrids and varieties) representing a wide range of silage agronomic and quality traits have been systematically evaluated using the same cropping practices. Four diverse hybrids have been included in all 6 years -- DeKalb FS-5, Pioneer 947, NK 300, and DeKalb FS-25E. Their silage agronomic performance is summarized in Table 2.

As expected, significant hybrid \times year interactions occurred for the four agronomic traits reported. The 1986 growing season favored the early- to mid-maturing hybrids, but 1987 favored the late-maturing hybrid. Summer droughts in both 1988 and 1989 and an early frost in 1989 reduced the yields for all four hybrids. Above average rainfall during the 1990 and 1992 growing seasons produced excellent whole-plant silage and grain yields. Relatively high lodging scores occurred in 3 of the 6 years.

Table 2. Agronomic Performance of the Four Forage Sorghum Hybrids Compared in Six of the Past Seven Years

Hybrid ^{1,2}	Plant height, inches						Lodging score, %					
	1986	1987	1988	1989	1990	1992	1986	1987	1988	1989	1990	1992
DeKalb FS-5	111	90	82	73	122	115	1	0	3	0	5	0
Pioneer 947	116	85	80	73	117	110	28	0	3	0	54	0
NK 300	86	68	65	58	78	72	2	0	0	0	3	67
DeKalb FS-25E	141	105	100	103	127	125	73	3	3	2	18	88

	Whole-plant DM yield, tons/acre						Grain yield, bushels/acre ³					
	1986	1987	1988	1989	1990	1992	1986	1987	1988*	1989	1990	1992
DeKalb FS-5	7.9	5.9	5.3	6.0	7.9	7.8	92	71	60	98	87	96
Pioneer 947	7.6	6.4	5.0	5.6	8.3	8.1	89	68	60	91	119	133
NK 300	8.0	7.0	4.2	5.5	7.4	8.9	82	79	75	77	105	173
DeKalb FS-25E	7.8	10.2	6.8	6.2	8.2	8.0	57	100	25	34	82	98

¹Season length: DeKalb FS-5, early to middle; Pioneer 947, middle; NK 300, middle to late; and DeKalb FS-25E, late. NK = Northrup King. Adjusted to 14.5% moisture. *Estimated.

WHOLE-PLANT CORN, FORAGE SORGHUM, AND GRAIN SORGHUM SILAGES FOR GROWING CATTLE

*B. S. Dalke, R. N. Sonon, S. M. Gramlich,
and K. K. Bolsen*

Summary

Agronomic and cattle performance traits were measured for eight silages produced in 1991. The silages were: irrigated Pioneer 3377 corn; dryland (early-planted) DeKalb 535 corn; irrigated and dryland DeKalb DK 42Y grain sorghum; and dryland forage sorghums Cargill 200F, Pioneer 947, Northrup King (NK) 300, and Funk's 102F. The irrigated corn and NK 300 and Funk's 102F forage sorghums had the highest whole-plant dry matter (DM) yields per acre; early-planted corn had the lowest yield. The dryland grain sorghum had the highest grain yield and the early-planted corn, the lowest. Average daily gains (ADG) were excellent for steers fed each of the eight silage rations and reflected the relatively high grain contents of the silages and the high DM intakes (2.37 to 2.81% of body wt). As expected, the irrigated corn silage produced the fastest and most efficient gain; the late-maturing, Funk's 102F forage sorghum produced the slowest and least efficient gain.

(Key Words: Silage, Corn, Forage Sorghum, Grain Sorghum.)

Introduction

Silage production in Kansas is primarily from irrigated and dryland corns and dryland forage and grain sorghums. Producers who grow or background cattle with high-silage rations tend to select silage crops or hybrids based on agronomic traits and nutritive values. In several earlier studies, we have documented the effects of growing season, hybrid, stage of maturity, processing, and grain addition on the yield potential and cattle performance from numerous forage and grain sorghum silages.

Irrigated and drought-stressed corn silages were compared in two studies. The objectives of this study were to compare both agronomic traits and cattle performance from eight silages produced in 1991.

Experimental Procedures

The crops were produced near the Kansas State University campus during the 1991 growing season. The eight silages included irrigated Pioneer 3377 corn; dryland (early-planted) DeKalb 535 corn; irrigated and dryland DeKalb DK 42Y grain sorghum; and dryland forage sorghums Cargill 200F, Pioneer 947, Northrup King 300, and Funk's 102F. The four fields used were of predominantly Reading silt loam soils. Prior to planting, anhydrous ammonia was applied at 100 lb per acre for both the irrigated and dryland corns and grain sorghums, and 80 lb per acre for the forage sorghums. The two corns were harvested at the 90% milk line stage of kernel maturity, and the six sorghums, at the very late-dough stage. All eight silages were made without a silage additive in 10 × 50 ft concrete stave silos.

The silos were opened on March 18 and 19, 1992 and were emptied at uniform rates during the next 3 months. Silage samples were taken three times weekly. Each silage was fed to 18 yearling, crossbred steers (three pens of six steers per silage) in a 70-day growing trial, which began on March 21, 1992. The complete-mixed rations were fed twice daily to appetite and contained 89% silage and 11% supplement on a DM basis. Rations were formulated to provide 12.1% crude protein, .52% calcium, and .28% phosphorus (DM basis); 250 mg of Rumensin; and 30,000 IU of

vitamin A per steer daily. Soybean meal was the main supplemental protein.

For 1 week before the start of the growing trial, all steers were limit-fed a forage sorghum silage ration to provide a DM intake of 2.0% of body weight. Steers were then weighed individually on 3 consecutive days. For 2 days before the final weighing, the steers were fed their respective silage rations at a restricted DM intake of 2.0% of body weight. Then individual weights were taken on 3 consecutive days.

Results and Discussion

Agronomic performance and chemical composition of the eight silage crops are shown in Table 1. The irrigated corn and dryland forage sorghums NK 300 and Funk's 102F had the highest whole-plant DM yields per acre; early-planted corn (DeKalb 535)

had the lowest yield. The extremely dry, hot weather throughout June and July contributed to the low silage and grain yields for the early-planted corn. Grain yields of the five dryland silage crops benefitted from early-August rainfall, and the grain sorghum had the highest yield. Grain yields of the four forage sorghums were average or above, but their whole-plant DM yields were below average. The CP and ADF values for the eight silages indicated that all were of relatively high nutritive value.

Average daily gains (Table 2) were excellent for steers fed the eight silage rations and reflected the relatively high silage grain contents and their high DM intakes (2.37 to 2.81% of body wt). As expected, irrigated corn silage produced the fastest and most efficient gain; the late-maturing, Funk's 102F forage sorghum produced the slowest and least efficient gain. However, the other five grain and forage sorghum silages compared favorably to irrigated corn silage for both agronomic and nutritive value traits.

Table 1. Agronomic Performance and Chemical Composition of the Eight Silages in 1991

Crop, hybrid, and growing condition	Planting date	Harvest date	Plant height, inches	Whole-plant		Grain yield, bu/acre ¹	Silage ²	
				DM, %	DM yield, tons/acre		CP, %	ADF, %
<u>Corn:</u>								
Pioneer 3377, irrigated	May 10	Aug. 13	96	33.3	6.5	120.0*	8.7	23.4
DeKalb 535, dryland early-planted	Apr. 1	July 16	91	33.1	4.1	18.2	8.7	28.1
<u>Grain sorghum: DeKalb 42Y</u>								
Irrigated	May 29	Aug. 28	49	37.7	5.6	105.3	10.0	25.1
Dryland	May 28	Sept. 17	42	39.2	5.6	122.4	9.8	20.5
<u>Forage sorghum: dryland</u>								
Cargill 200F	June 6	Aug. 16	70	38.2	5.0	91.5	9.1	28.8
Pioneer 947	June 6	Aug. 20	77	34.1	5.7	96.0	8.5	28.9
Northrup King 300	June 6	Sept. 27	56	38.3	6.4	101.6	7.9	29.0
Funk's 102F	June 6	Oct. 9	83	39.1	6.4	83.4	7.8	29.8

¹Bushels/acre adjusted to 14.5% moisture.

²CP = crude protein, ADF = acid detergent fiber, and both are reported on a DM basis.

*Estimated.

Table 2. Performance by Yearling Steers fed the Eight Silage Rations

Item	Corn		Grain sorghum,		Forage sorghum			
	Pioneer 3377	DeKalb 535	DeKalb 42Y		Cargill 200F	Pioneer 947	NK 300	Funk's 102F
	irrigated	dryland	irrigated	dryland				
No. of steers	18	18	18	18	18	18	18	18
Initial wt, lb	640	634	642	646	633	634	626	637
Avg daily gain, lb	2.67 ^a	2.37 ^{bc}	2.43 ^{bc}	2.52 ^b	2.30 ^{bc}	2.35 ^{bc}	2.33 ^{bc}	2.22 ^c
Daily DM intake, lb	18.9 ^b	17.0 ^c	19.9 ^{ab}	20.6 ^a	18.7 ^b	18.8 ^b	19.1 ^b	20.0 ^{ab}
Feed/lb of gain, lb ¹	7.1 ^a	7.2 ^{ab}	8.2 ^{bc}	8.2 ^{bc}	8.2 ^{bc}	8.0 ^b	8.2 ^{bc}	9.0 ^c

¹100% DM basis.

^{abc}Means in the same row with different superscripts differ (P < .05).

EFFECTS OF HYBRID, GROWING CONDITION, STORAGE TIME, AND PIONEER 1174® SILAGE INOCULANT ON AGRONOMIC PERFORMANCE AND NUTRITIVE VALUE OF WHOLE-PLANT CORN AND GRAIN SORGHUM SILAGES¹

R. Suazo², R. N. Sonon, and K. K. Bolsen

Summary

In 1989, two Pioneer corn hybrids, 3377 and 3389, were grown under irrigation and harvested at 80% milk line kernel maturity. Voluntary intakes and ADF digestibilities were similar for all hybrid, inoculant, and storage time combinations; however, DM digestibility was higher for 3377 silage than for 3389, and DM, CP, and NDF digestibilities were higher at the 50- than the 250-day storage time. The inoculant did not influence either voluntary intake or digestibility.

In 1990, the same corn hybrids and DeKalb DK 42Y and Pioneer 8358 grain sorghum hybrids were grown under both irrigated and dryland conditions. Whole-plant DM contents were similar for irrigated hybrids, but dryland corns had lower DM values than sorghums. Whole-plant DM yields were higher for irrigated hybrids, and irrigated corns had higher yields than irrigated grain sorghums. Grain yields were higher for dryland grain sorghums than for dryland corns. Significant crop × growing condition × storage time interactions occurred for voluntary intake, DM, NDF, and ADF digestibilities. At 50 days, voluntary intake was higher for grain sorghums, and whole-plant DM digestibilities were similar within each crop, but grain sorghum silages had lower digestibilities than corn silages. At 50 days, voluntary intake was similar for all silages, and DM digestibility was higher for

irrigated corn silages than for dryland corn silages and for all grain sorghum silages.

The agronomic performances of the irrigated and dryland grain sorghums suggest that they are equivalent to dryland corn silage. Irrigated and dryland grain sorghum silages were of similar nutritive quality to the corn silages.

(Key Words: Corn, Sorghum, Silage, Hybrid, Inoculant.)

Introduction

Silage production in the United States is dominated by corn. Producers who grow their own corn or cattlemen who purchase corn for silage tend to select hybrids more for high grain-yield potential than for good silage traits. Previously, we found that irrigated silages, with a higher percentage of grain, were not more digestible than dryland silages (KAES Report of Progress 592, page 110). Irrigated and dryland grain sorghums had higher silage and grain yields than to dryland corn.

There is a long standing belief that, once ensiled material reaches the stable phase, all biological processes cease. However, there are few if any research data to confirm that belief.

Our objectives were: 1) to continue evaluating corn and grain sorghum hybrids for

¹Partial financial assistance was provided by Pioneer Hi-Bred International, Inc., North American Seed and Microbial Genetics Divisions, Des Moines, Iowa.

²Former graduate student. Current address: San Pedro Sula, Honduras.

silage agronomic performance and 2) to evaluate the effects of irrigated and dryland growing conditions, storage time, and Pioneer 1174® inoculant on the nutritive value of corn and sorghum silages.

Experimental Procedures

Experiment 1: 1989. Two mid-maturing Pioneer corn hybrids, 3377 and 3389, were grown under irrigation in 1989 on a Reading silt loam soil near the Kansas State University campus. Both hybrids were planted on May 4. Prior to planting, anhydrous ammonia was applied at 100 lb per acre. Soil tests indicated that phosphorus and potassium were adequate. Furadan 15G insecticide was applied in the furrows at planting, followed the next day by Ramrod-atrazine preemergence herbicide. The experiment was arranged in a completely randomized design. Each plot had six, 400 ft long rows, 30 in. apart. Both hybrids were harvested when the kernels at the center of the ear reached approximately 80% milk line stage of maturity.

Agronomic data collected for each hybrid included plant density, plant height, plant part proportions, grain yield, and whole-plant dry matter (DM) content and yield. Whole-plant DM yields were determined by harvesting six rows with a FieldQueen forage harvester. The fresh material was weighed, mixed, sampled, then divided in half and treated with distilled water (control) or Pioneer 1174® silage inoculant at the recommended rate. The material was ensiled in 55 gal., plastic-lined, metal drum, pilot silos. They were filled, compacted, weighed, sealed, randomly assigned to 50- or 250-day storage times, and stored outside at ambient temperature until emptied and fed.

Twenty eight, mature, crossbred wethers were blocked by weight and randomly assigned (seven per silage) to the four silages for voluntary intake and digestion trials. Each trial consisted of 10-day silage adaptation, 7-day voluntary intake, 2-day adjustment to 90% of voluntary intake, and 6-day total fecal collection phases. Rations were 90% silage and 10% supplement (DM basis), formulated to 11.5% crude protein. The wethers

averaged 101 lb at the start of the 50-day storage trial and 107 lb for the 250-day storage trial.

Experiment 2: 1990. Pioneer 3377 and 3389 corn hybrids and two mid-maturing grain sorghum hybrids, Pioneer 8358 and DeKalb DK 42Y, were planted under both irrigated and dryland conditions in 1990, using the same field and culture practices as in Experiment 1. The corn and grain sorghum hybrids were planted on May 2 and May 23, respectively. The experiment was a $2 \times 2 \times 2 \times 2$ factorial; two growing conditions (irrigated and dryland), two corn hybrids, two sorghum hybrids, and two storage times (50 and 250 days), in a split-plot design. Hybrids were randomly assigned to a plot within each growing condition for each of three replications. Each plot had six, 125 ft long rows, 30 in. apart. Corns were harvested when the middle kernels of the ear reached 80% milk line; sorghums when the middle kernels of the head reached late-dough.

The chopped material from the three replicates of each crop was composited; mixed; treated with Pioneer 1174® silage inoculant at the recommended rate; and ensiled in 55 gal., plastic-lined, metal drum pilot silos.

Forty mature, crossbred wethers were blocked by weight and randomly assigned to the eight silages for voluntary intake and digestion trials. The wethers averaged 99 lb at the start of the 50-day trial and 110 lb for the 250-day storage trial. All other procedures were as in Experiment 1.

Results and Discussion

Agronomic performance and plant part proportions for the 10 silage crops in the two experiments are presented in Table 1. In 1989, Pioneer 3377 had a higher proportion of grain than Pioneer 3389; however, in 1990, the two hybrids were similar within each growing condition. In 1990, whole-plant DM yields were higher for the four irrigated hybrids than their dryland counterparts, and the irrigated corns had higher total silage yields than irrigated grain sorghums. Grain

yields were higher for the dryland grain sorghums than for dryland corns.

Dry matter content and chemical composition for the 50- and 250-day silages in Experiments 1 (1989) and 2 (1990) are shown in Tables 2 and 3, respectively. In both years, DM and ADF contents generally increased with storage time, indicating water loss and metabolism of soluble components during storage. In Experiment 2, CP content was much more variable for the corn than for the sorghum silages, ranging from 9.1 to 12.5% and 9.6 to 11.4%, respectively. At both 50 and 250 days, the two dryland corn silages had higher CP and ADF values than the two irrigated corn silages.

Nutritive values of the silages in Experiments 1 and 2 are presented in Tables 4 and 5, respectively. In Experiment 1, voluntary intakes (VI) and ADF digestibilities were similar for all hybrid, inoculant, and storage time combinations; however, DM digestibility was higher for 3377 silage than 3389, and DM, CP, and NDF digestibilities were higher at the 50- than 250-day storage

time. The Pioneer 1174 inoculant did not influence either VI or digestibilities for any hybrid or storage time combination.

In Experiment 2 (Table 5), significant crop by growing condition by storage time interactions occurred for VI and DM, NDF, and ADF digestibilities. At 50 days, intakes were higher for sorghum than for corn silage. The difference had disappeared by 250 days. At 50 days, digestibility was higher for corn than sorghum silage, with no difference due to irrigation. By 250 days, irrigated corn silage was more digestible than dryland, but there was no irrigation effect for sorghum silage.

The agronomic performance (Table 1; 1990 data) of both crops was significantly affected by growing condition, and the two corn hybrids were affected much more than the two sorghum. These data also suggest that under dryland conditions, grain sorghum is equivalent to corn for silage production. Furthermore, irrigated and dryland grain sorghum silages were of similar nutritional quality to the corn silages.

Table 1. Harvest Date; Plant Density; Plant Height; Dry Matter (DM) Content; Whole-plant DM, Grain, and Stover Yields; and Plant Part Proportions of the Corn and Grain Sorghum Hybrids in Experiments 1 (1989) and 2 (1990)

Hybrid	Harvest date	Plants/acre	Plant height, inches	Whole-plant DM and DM yield,		Grain yield, bu/A ²	Plant part proportions, %		
				%	T/A ¹		grain	stover	head or cob
Corn									
3377	Aug. 30	17,000	102	30.0	5.0	115.7	44.4	45.1	10.5
3389	Aug. 24	18,900	102	27.6	5.5	108.1	36.3	51.8	11.9
Corn									
3377	Aug. 22	20,500	94	32.8	6.1	126.7	44.8	45.9	9.3
3389	Aug. 19	19,500	90	30.9	6.5	115.7	44.1	47.0	8.9
Sorghum									
DK42Y	Aug. 30	43,000	56	32.5	4.4	65.3	42.6	42.9	14.5
8358	Aug. 28	43,600	60	32.9	5.0	98.8	47.6	38.6	13.8
Corn									
3377	Aug. 23	20,350	90	29.0	4.3	18.6	28.4	60.9	10.7
3389	Aug. 22	19,600	88	29.5	4.1	22.4	25.8	63.3	10.9
Sorghum									
DK42Y	Sept. 1	42,400	49	38.1	4.0	60.0	39.5	47.1	13.4
8358	Sept. 3	42,300	47	33.6	4.0	78.3	43.9	43.4	12.9

¹Tons per acre. ²Bushels per acre; adjusted to 14.5% moisture.

Table 2. Dry Matter Content and Chemical Composition for the 50- and 250-Day Corn Silages in Experiment 1 (1989)

Hybrid and inoculant treatment	DM ¹ %	CP)))) % of the silage DM))))	NDF)))) % of the silage DM))))	ADF
<u>3377</u>))))))) 50 day silage)))))))				
Control	30.6	9.8	62.7	21.1
1174	30.0	9.8	60.0	21.3
<u>3389</u>				
Control	28.0	9.0	59.0	26.5
1174	28.0	9.4	62.4	23.3
<u>3377</u>))))))) 250 day silage)))))))				
Control	33.5	8.6	55.8	22.1
1174	34.9	8.9	52.2	21.5
<u>3389</u>				
Control	31.5	8.3	62.3	28.8
1174	32.3	8.5	63.5	26.7

¹DM = dry matter; CP = crude protein; NDF = neutral detergent fiber; and ADF = acid detergent fiber.

Table 3. Dry Matter Content and Chemical Composition for the 50- and 250-Day Corn

Hybrid and growing condition ¹	DM ² %	CP)))) % of the silage DM))))	NDF)))) % of the silage DM))))	ADF
<u>Corn</u>))))))) 50 day silage)))))))				
3377 I	28.9	10.8	70.8	28.7
3377 D	24.2	12.5	65.5	30.5
3389 I	30.0	9.1	67.7	29.1
3389 D	25.2	12.3	64.0	31.8
<u>Sorghum</u>				
DK 42Y I	30.8	11.1	65.2	32.1
DK 42Y D	37.1	11.0	64.4	28.5
8358 I	32.2	9.6	59.6	26.3
8358 D	32.6	10.8	55.2	27.2
<u>Corn</u>))))))) 250 day silage)))))))				
3377 I	31.8	10.1	63.7	29.7
3377 D	25.0	12.2	62.3	31.3
3389 I	33.1	9.2	60.1	27.5
3389 D	27.5	12.4	63.3	33.8
<u>Sorghum</u>				
DK 42Y I	31.7	11.4	61.3	34.5
DK 42Y D	37.5	11.4	61.2	26.1
8358 I	33.4	10.4	57.6	33.6
8358 D	34.6	11.2	55.8	30.0

¹I = irrigated and D = dryland. ²DM = dry matter; CP = crude protein; NDF = neutral detergent fiber; and ADF = acid detergent fiber.

Table 4. Main Effects of Corn Hybrid, 1174 Inoculant, and Storage Time on Voluntary Intake and Nutrient Digestibilities for the Silage Rations in Experiment 1 (1989)

Main effect	VI ¹	Digestibility, %			
		DM	CP	NDF	ADF
Hybrid					
3377	81.4	71.7 ^a	68.8	62.8	43.4
3389	83.0	69.3 ^b	68.2	62.6	47.7
Inoculant					
Control	81.0	70.6	67.9	63.1	47.2
1174	83.4	70.4	69.1	62.2	43.8
Storage time					
50 days	81.5	71.7 ^a	69.6 ^a	65.3 ^a	45.7
250 days	82.9	69.3 ^b	67.4 ^b	60.0 ^b	44.8

¹VI = voluntary intake as g of DM per kg body wt⁷⁵; DM = dry matter; CP = crude protein; NDF = neutral detergent fiber; and ADF = acid detergent fiber.

^{ab}Means in the same column within main effects with different superscripts differ significantly (P < .05).

Table 5. Effects of Crop, Hybrid, and Growing Condition on Voluntary Intake and Nutrient Digestibilities for the 50- and 250-Day Silage Rations in Experiment 2 (1990)

Hybrid and growing condition ¹	VI ²	Digestibility, %			
		DM	CP	NDF	ADF
Corn)))))) 50 day silage))))))))			
3377 I	85.1 ^b	63.6 ^a	68.5 ^{abc}	59.5 ^{ab}	42.1 ^{bc}
3377 D	82.8 ^b	65.1 ^a	70.4 ^{ab}	60.7 ^{ab}	52.4 ^a
3389 I	88.3 ^{ab}	65.1 ^a	67.2 ^{abc}	61.9 ^a	49.2 ^{ab}
3389 D	81.1 ^b	62.7 ^a	71.8 ^a	56.5 ^{bc}	49.4 ^{ab}
Sorghum					
DK 42Y I	89.5 ^a	59.7 ^b	69.6 ^{ab}	53.6 ^{cde}	45.7 ^{abc}
DK 42Y D	97.8 ^a	60.4 ^b	65.2 ^{bc}	56.0 ^{bcd}	46.3 ^{abc}
8358 I	92.0 ^a	60.2 ^b	63.8 ^c	50.8 ^{de}	31.8 ^d
8358 D	96.6 ^a	61.4 ^b	65.4 ^{bc}	48.8 ^e	41.4 ^c
Corn)))))) 250 day silage))))))))			
3377 I	93.5	66.0 ^a	67.9 ^{abc}	54.8 ^{ab}	46.5 ^a
3377 D	88.5	60.2 ^b	70.8 ^{ab}	48.1 ^{cd}	41.3 ^{ab}
3389 I	88.8	67.2 ^a	66.1 ^{bc}	55.9 ^a	46.8 ^a
3389 D	93.2	61.1 ^b	69.0 ^{abc}	49.2 ^{bcd}	44.2 ^a
Sorghum					
DK 42Y I	89.0	60.9 ^b	72.4 ^a	49.3 ^{bcd}	47.5 ^a
DK 42Y D	96.8	62.4 ^b	69.9 ^{abc}	50.7 ^{abc}	35.3 ^b
8358 I	93.1	60.2 ^b	66.1 ^{bc}	45.7 ^{cd}	45.4 ^a
8358 D	97.5	59.9 ^b	64.8 ^c	43.9 ^d	42.7 ^{ab}
Crop × Cond. × Time (P level) ³	.004	.001	NS	.001	.003

¹I = irrigated and D = dryland.

²VI = voluntary intake as g of DM per kg body wt⁷⁵; DM = dry matter; CP = crude protein; NDF = neutral detergent fiber; and ADF = acid detergent fiber.

³Crop by growing condition by storage time interaction and level of significance.

^{abcde}Means in the same column and within storage time with different superscripts differ significantly (P < .05).

EFFECT OF BACTERIAL INOCULANTS ON THE PRESERVATION OF ALFALFA AND WHOLE-PLANT CORN SILAGES¹

K. K. Bolsen, R. N. Sonon, and B. S. Dalke

Summary

Inoculated and control alfalfa and corn silages were compared in pilot-scale silos. Inoculated silages for both crops had higher lactic acid contents and DM recoveries and lower values for pH, acetic acid, ethanol, and ammonia-nitrogen than controls—evidence that the inoculants produced a more efficient fermentation. These results are consistent with numerous studies that compared untreated and inoculant-treated silages over a wide range of crops and ensiling conditions in our research during the past several years.

(Key Words: Silage, Inoculant, Preservation, Alfalfa, Corn.)

Introduction

It has become common practice in silage-making to add selected strains of lactic acid bacteria (LAB). These are intended to dominate the initial phase of the ensiling process. However, numerous characteristics of the forage to be ensiled—species, DM content, water-soluble carbohydrate content, and buffering capacity—interact with epiphytic (natural occurring) and inoculant microbes to determine the outcome of the fermentation. The objective of this study was to continue to document the effect of commercial bacterial inoculants on the preservation of alfalfa and whole-plant corn silages.

Experimental Procedures

Second cutting, Cody alfalfa was mowed and swathed in the 10% bloom stage of maturity at 2:00 p.m. on June 5, 1990 and wilted in the windrow for 24 h prior to precision chopping with a FieldQueen forage harvester. Four, 5.0 ft diameter × 5.0 ft high, concrete, pilot-scale silos were filled with the chopped material within a 2 1/2 h period. Alternating, 400 lb lots of alfalfa were used in a random order to fill the four silos. For two of the silos, each 400 lb of alfalfa received Biomax[®] SI inoculant at a rate of 1.9 liters per ton, which supplied 1×10^5 colony-forming units (cfu) of LAB/g of crop. The alfalfa in the other two silos received an equivalent amount of distilled water. A 1.0 lb sample of each lot was taken for DM determination. All silos were sealed with weighted polyethylene sheeting and opened after 90 days; the silage was removed, weighed, mixed, and sampled (six samples per silo).

On August 27, 1990, irrigated whole-plant corn (Pioneer 3377) in the 90% milk line stage of kernel development was chopped with a FieldQueen forage harvester. Four, pilot-scale silos were filled with the chopped material. For two of the silos, each 400 lb of corn received Qwik-N-Sile[®] inoculant at a rate of 1.0 lb per ton, which supplied 1×10^5 cfu of LAB/g of crop. The chopped material in the other two silos

¹Financial assistance and the two inoculants were provided by Chr. Hansen's Bio Systems, Milwaukee, Wisconsin.

received ground grain sorghum at a rate of 1.0 lb per ton. All other procedures were similar to those described for the alfalfa trial.

Results and Discussion

Shown in Table 1 are the effects of the two inoculants on the DM recovery and fermentation characteristics of the alfalfa and whole-plant corn silages. The data for both crops are consistent with several of our previous inoculant studies using laboratory-scale, pilot-scale, and farm-scale silos. Biomax® SI-treated alfalfa silages had a significantly higher lactic acid content and significantly lower values for pH, acetic

acid, ethanol, and ammonia-nitrogen than controls—evidence that the inoculant produced a more efficient fermentation. Qwik-N-Sile®-treated corn silages had significantly higher lactic acid and lower acetic acid and ethanol values. Both inoculated silages had higher DM recoveries than their control counterparts; ($P < .06$) for alfalfa and ($P < .05$) for corn.

Based upon results from several earlier studies, we would expect the better preserved, inoculated silages in this study to have higher nutritive value than the untreated (control) silages (KAES Report of Progress 651, page 101).

Table 1. Effect of Biomax® SI and Qwik-N-Sile® Inoculants on Dry Matter (DM) Recovery and Fermentation Characteristics of the Alfalfa and Corn Silages

Item ^{1,2}	Alfalfa			Whole-plant corn		
	Control	Biomax SI	P	Control	Qwik-N-Sile	P
Dry matter, %	44.2	44.9	---	36.8	37.4	---
DM recovery, % of the DM ensiled	92.60	93.84	.06	91.80	92.70	.08
pH	4.67	4.55	.002	3.78	3.80	NS ³
))))))))) % of the silage DM)))))))))))				
Lactic acid	4.63	5.38	.001	6.45	7.08	.01
Acetic acid	2.82	2.20	.01	3.29	2.65	.07
Ethanol	.132	.080	.002	.369	.217	.03
Ammonia-nitrogen	.214	.158	.008	.143	.129	NS

¹The DM recovery values are the means of two, pilot-scale silos.

²Dry matter content and fermentation values are the mean of 12 samples (six per silo).

³NS = not significant.

RATE AND EXTENT OF LOSSES FROM TOP SPOILAGE IN ALFALFA SILAGES STORED IN BUNKER SILOS¹

***D. L. Holthaus, M. A. Young, D. R. Bonilla, L. Pfaff,
D. Haverkamp, B. S. Dalke, R. N. Sonon, K. Budiongo,
and K. K. Bolsen***

Summary

Alfalfa silages were made in pilot- and farm-scale silos, and five sealing treatments were compared. After 90 days, sealing dramatically reduced DM losses at the 5 and 10 in. depths in the farm silos and at the 0 to 12, 12 to 24, and 24 to 36 in. depths in the pilot silos. Extending the storage period to 180 days in pilot silos had no effect on DM losses for sealed or delay sealed silages, but DM losses for unsealed silages continued to increase at all three depths. Placing a roof over the unsealed, farm-scale silo increased the silage DM content at all three depths, increased storage temperatures at the 10 and 20 in. depths, and reduced DM loss at the 10 in. depth compared to the unsealed silo without a roof. Rainfall was much above normal (16.8 in. during the first 90 days of storage; 11.2 in. the second 90 days) and contributed to huge increases in the moisture content of silage at the lower depths in the unsealed, no roof, pilot- and farm-scale silos.

(Key Words: Silage, Alfalfa, Top Spoilage, Bunker Silos.)

Introduction

Large horizontal silos (i.e., bunkers, trenches, and stacks) are economical for storing large quantities of ensiled feeds, but by design, much of the silage is exposed to the environment. In a silo with about 1,000 tons capacity (100 ft long × 40 ft wide × 12 ft deep), up to 25% of the original silage mass is

within the top 3 feet. In an earlier study with alfalfa, we found that DM losses in an unsealed bunker exceeded 72 and 32% in the top 0 to 12 and 12 to 24 inches, respectively, after 12 wks of storage (KAES Report of Progress 623, page 74). However, sealing with polyethylene sheeting reduced the DM losses to less than 8% at each depth.

Our objectives were: 1) to continue measuring the rate and extent of top spoilage losses in unsealed and sealed alfalfa silages and 2) to determine the effects of delaying sealing and of placing a roof over the silage mass on preservation efficiency. To our knowledge, the feasibility of using a roof to protect an unsealed silage mass from rain and snowfall has not been studied in controlled experiments.

Experimental Procedures

Farm-scale silos. On June 25 and 26, 1992, second cutting alfalfa was chopped and packed into four, 16 ft long × 13.5 ft wide × 4 ft deep, bunker silos. Alternate loads were used to fill the bottom half of each silo on the first day and the top half of each silo on the second day. All alfalfa was cut with a mower-conditioner and allowed to wilt for 24 h before chopping. While the silos were being filled, nylon net bags, each containing 4.4 lb of fresh material, were placed at depths of 5, 10, and 20 in. from the surface of the initial ensiled mass (3 bags/depth/silo). Thermocouples were placed at each bag location, and temperatures were recorded daily for the first 30 days, then twice weekly thereafter. The silos contained

¹Financial assistance was provided by Kemin Industries Inc., Des Moines, Iowa and Mr. Richard Porter, Porter Farms, Reading, Kansas.

similar amounts of fresh material and were packed with tractors to densities that were similar to farm-scale conditions.

Treatments were: 1) left unsealed, without a roof; 2) sealed, without a roof; 3) left unsealed, with a roof; and 4) sealed, with a roof. Both sealed silos were covered with a single sheet of .4 mm polyethylene, weighted with tires. A galvanized, tin roof was used for treatments 3 and 4 (Figure 1). Bunkers were emptied at 90 days postfilling. The nylon net bags were recovered after the settling depths had been recorded, and the silage was weighed, mixed, sampled, and analyzed for DM and pH.

Pilot-scale silos. The same chopped alfalfa that was used to fill the farm-scale silos was packed to equal densities into 33, polyethylene-lined, 55-gal drum, pilot-scale silos. Each drum was divided horizontally into thirds with nylon netting to partition the fresh material at 12 and 24 in. below the initial surface. A perforated 1.0 in. PVC pipe was placed at the bottom of the drums and connected through an air lock to drain percolated water. The first four treatments were the same as those described for the farm-scale silos, plus a fifth treatment in which sealing was delayed 7 days. All sealed silos were covered with a single .4 mm sheet of polyethylene; silos designated as not roofed were stored outside; silos designated as roofed were stored in an open-sided, metal building.

The "unroofed" pilot-scale silos were opened at 7, 90, and 180 days postfilling; the "roofed" silos were opened at 90 and 180 days; and delayed-seal silos were opened at 180 days. There were three silos per treatment at each opening time; the silage at each depth was weighed, mixed, and sampled; and the samples were analyzed for DM and pH. The distance that each nylon net partition had settled from the initial surface in each silo was also recorded.

Results and Discussion

The effects of sealing treatment, depth from the initial surface, and days postfilling on the preservation efficiency traits measured are shown in Table 1 and Figure 2 (farm-scale silos) and Table 2 (pilot-scale silos).

In the farm-scale silos, sealing (with or without a roof) dramatically reduced silage DM losses and storage temperatures at the 5 and 10 in. depths. The silages in the two sealed silos were well preserved at all three depths, but only the silage at the 20 in. depth in the two unsealed silos was of acceptable quality. Silage DM losses at the 20 in. depth ranged from 6.3 to 12.8% in the four silos. Temperatures in the two sealed silos peaked within the first 3 days postfilling; temperatures in the unsealed, no-roof silo peaked within the first 3 to 4 wks; but temperatures in the unsealed, roof silo remained high for the longest time, particularly at the 20 in. depth. The unusually high rainfall during the 90-day storage (16.8 in.) produced a large amount of percolated water through the unsealed, no-roof silage; and the silages at the 10 and 20 in. depths were 10.1 and 15.3 percentage units wetter than the pre-ensiled forage. In contrast, the silages at the 10 and 20 in. depths in the unsealed, roof silo were actually 22.3 and 2.3 percentage units drier than the pre-ensiled forage, as considerable dehydration/evaporation took place in the absence of a seal. Placing a roof over the unsealed silage did not affect DM losses at the 5 and 20 in. depths, but it did reduce DM loss from 52.4 to 23.4% at the 10 in. depth.

In the pilot-scale silos, sealing (with or without a roof) produced similar preservation traits (i.e., DM content, DM recovery, and pH) as the farm-scale silos after 90 days of storage; and there was little, if any, additional deterioration after 180 days. In general, the pilot-scale, unsealed, roof silos had similar silage preservation traits to the farm-scale silo; however, silages in the pilot-scale, unsealed, no-roof silos at 90 days were much more

deteriorated than their farm-scale counterpart. This is explained, in part, by a greater influence of the side-wall in the 2.1 ft diameter pilot silos vs. the 13.5 ft wide farm silos. Delayed sealing (7 days) resulted in a dramatic improvement in preservation efficiency in the top 36 in. of silage compared to no seal, which is consistent with our

previous studies with corn and forage sorghum silages (KAES Report of Progress 651, page 135).

These data document that sealing alfalfa silage in bunker silos greatly increases preservation efficiency in the initial top 3 ft of ensiled material.

Table 1. Effects of Sealing Treatment and Depth from the Initial Surface on the Settling Distance, Dry Matter (DM) Content, DM Recovery (Rec.), pH, and Maximum Temperature (Temp.) of the Alfalfa Silages Stored in Farm-scale Bunker Silos

Sealing treatment	Initial depth, inches	Distance settled, inches ¹	Initial DM, %	90-day silage			Maximum temp., ³
				DM, %	DM rec. ²	pH	
Unsealed, no roof	5.0	3.0	55.3	65.4	66.4	8.21	148.3 (16)
	10.0	---	55.3	45.2	47.6	8.68	147.3 (17)
	20.0	4.6	50.8	35.5	90.6	4.85	125.9 (24)
Sealed, no roof	5.0	1.5	54.9	52.9	90.7	5.23	107.1 (1)
	10.0	---	54.9	52.7	91.1	5.28	110.0 (1)
	20.0	2.2	50.4	47.2	89.5	5.20	113.6 (1)
Unsealed, roof	5.0	< 1.0	53.4	72.0	64.2	8.10	142.5 (17)
	10.0	---	53.4	75.7	76.6	7.57	148.8 (35)
	20.0	< 1.0	47.2	49.5	87.2	4.63	134.7 (82)
Sealed, roof	5.0	< 1.0	56.8	57.8	91.5	5.41	111.0 (2)
	10.0	---	56.8	57.7	89.9	5.41	112.7 (3)
	20.0	1.4	50.3	53.8	93.7	5.20	108.9 (1)

¹Depth settled during the 90-day storage period was not recorded at the 10-inch depth.

²Expressed as a % of the DM ensiled.

³The day postfilling when the maximum temperature occurred is shown in parentheses.

Table 2. Effects of Sealing Treatment, Depth from the Initial Surface, and Day Post-filling on Dry Matter (DM) Content, DM Recovery (Rec.), and pH of the Alfalfa Silages Stored on Pilot-scale Silos¹

Sealing treatment	Initial depth, inches	Day post-filling	DM, %	DM, rec. ²	pH
Unsealed, no roof	0 to 12	7	54.3	95.1	6.72
		90	27.1	37.8	7.71
		180	24.3	35.5	8.28
	12 to 24	7	52.2	95.7	5.53
		90	22.7	66.8	5.03
		180	21.3	59.3	5.74
	24 to 36	7	52.7	98.1	5.56
		90	23.5	77.9	4.90
		180	18.3	65.9	5.11
Sealed, no roof	0 to 12	7	52.4	95.4	5.50
		90	49.1	92.0	5.08
		180	46.8	93.2	5.01
	12 to 24	7	52.3	97.0	5.58
		90	52.1	93.6	5.26
		180	47.8	94.1	5.08
	24 to 36	7	52.6	97.3	5.62
		90	50.2	94.5	5.10
		180	48.9	93.2	5.07
Unsealed, roof	0 to 12	90	56.8	73.9	8.94
		180	47.9	57.4	8.96
	12 to 24	90	47.6	84.2	6.81
		180	45.1	80.8	6.63
	24 to 36	90	54.5	96.2	5.26
		180	49.9	90.4	5.10
Sealed, roof	0 to 12	180	50.4	92.5	5.06
	12 to 24	180	51.3	93.0	5.06
	24 to 36	180	50.9	91.5	5.02
Delay-sealed, no roof	0 to 12	90	49.4	87.3	5.33
		180	52.8	84.3	5.36
	12 to 24	90	51.4	93.4	5.16
		180	54.2	92.4	5.14
	24 to 36	90	49.9	94.7	5.12
		180	51.9	90.6	5.10

¹Each value is the mean of three pilot-scale silos.

²Expressed as a % of the DM ensiled.

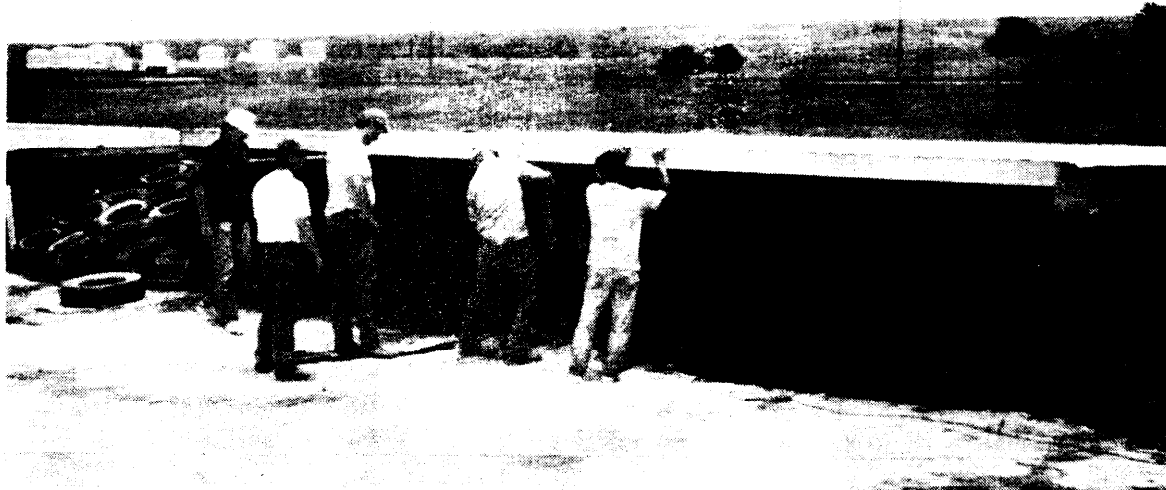

Figure 1. Attaching the Roofs to the Two Bunker Silos

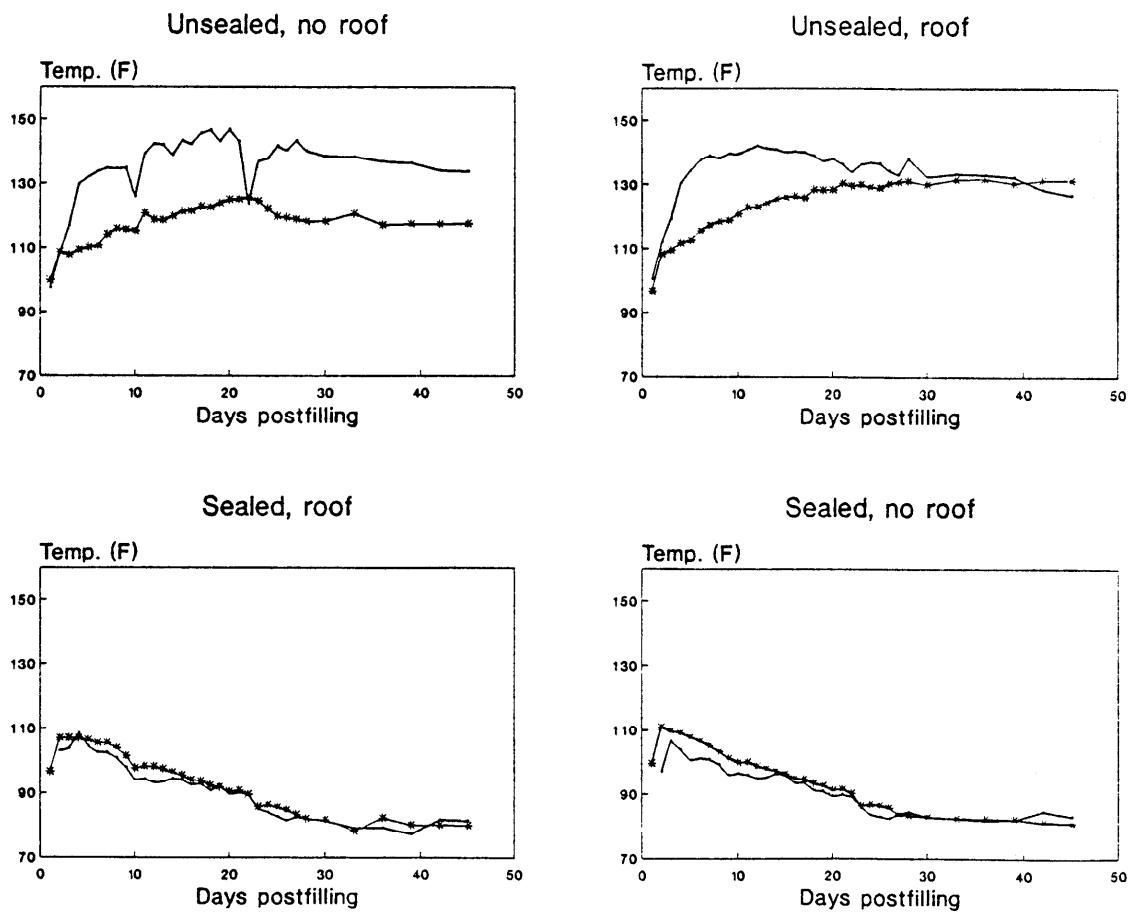

Figure 2. Effect of Sealing Treatment on the Temperature of the Alfalfa Silages during the First 6 Weeks of Storage in the Farm-scale Silos (depth below the initial surface: —□— = 5 inches and +- 20 inches)

A LABORATORY SYSTEM FOR MODELING HAY STORAGE

W. K. Coblentz¹, J. O. Fritz¹, and K. K. Bolsen

Summary

A simple system is described that uses a hinged metal baling unit and a hydraulic press to make $4.0 \times 4.3 \times 5.3$ inch wire-tied, laboratory-scale, hay bales. A comparison of densities of conventional, small, alfalfa bales ($15 \times 18 \times 37$ inches) and laboratory bales was made over a wide range of moisture levels (15 to 36%) and conventional bale densities (10 to 25 lb/ft³). Laboratory bale densities were regressed against conventional bale densities and agreement was excellent. The system is inexpensive to build and easy to use and can be reproduced easily.

(Key Words: Hay, Bale, Laboratory-scale, Alfalfa.)

Introduction

Packaging and preserving forage as hay continue to be areas of intense interest. Being able to make small, laboratory-scale, hay packages that simulate conventional hay bales for characteristics such as heat generation, mold development, and quality changes in both hay stack and isolated environments would facilitate hay research. Our objective was to develop a simple system for making wire-tied, laboratory-scale, alfalfa hay bales that were comparable to conventional bales over a wide range of densities.

Experimental Procedures

Design and Description. The baling unit (Figure 1) was constructed of 3/16 in.-thick

(10 gauge) black iron plate. All hardware attached to the bale chamber (hinges, fasteners, and bale chamber support) were welded into place. The corners of the bale chamber without hinges or fasteners were bent at right angles. Two 4×4 in., tight pin, plain steel hinges were used to hinge the unit. Three 4 in. barrel bolt latches were used to close the unit. Four slots were cut in the bale chamber to provide for wire ties. Slots were wider near the bottom to make tying easier.

The press block was a $3 \frac{1}{2} \times 3 \frac{1}{2} \times 1 \frac{1}{2}$ in. wooden block fastened to a $3 \frac{1}{2} \times 3 \frac{1}{2} \times 3/16$ in. metal plate with four $1 \frac{1}{4}$ in. lag screws. An attachment was then welded to the metal plate to fasten the press block to the hydraulic press. Two grooves $3/8$ in. wide and $1/4$ in. deep were cut across the face of the press block to maintain wire spacing during bale formation.

The base of the baling unit was a $7 \frac{1}{16} \times 7 \frac{1}{16} \times 1/4$ in. metal plate with four $3/4 \times 3/4 \times 1/8$ in. angle base chamber supports welded in place to prevent the bale chamber from expanding during bale formation. Inside the square, a $3 \frac{1}{2} \times 3 \frac{1}{2} \times 3/4$ in. wooden block was attached such that the bale chamber fit neatly between the base bale chamber supports and the block. Two grooves were cut across the face of the block to maintain the bale wires in the correct position during bale formation. The grooves in the press block, bale chamber, and base block were aligned and positioned such that the tie wires on the hay bale were approximately 2 in. apart and 1 in. from each edge of the bale. The tie wires

¹Department of Agronomy.

were common baler wire and were bent prior to the baling. We have found that a simple 4 x 4 x 12 in. wooden block works well as a mold for bending the wires.

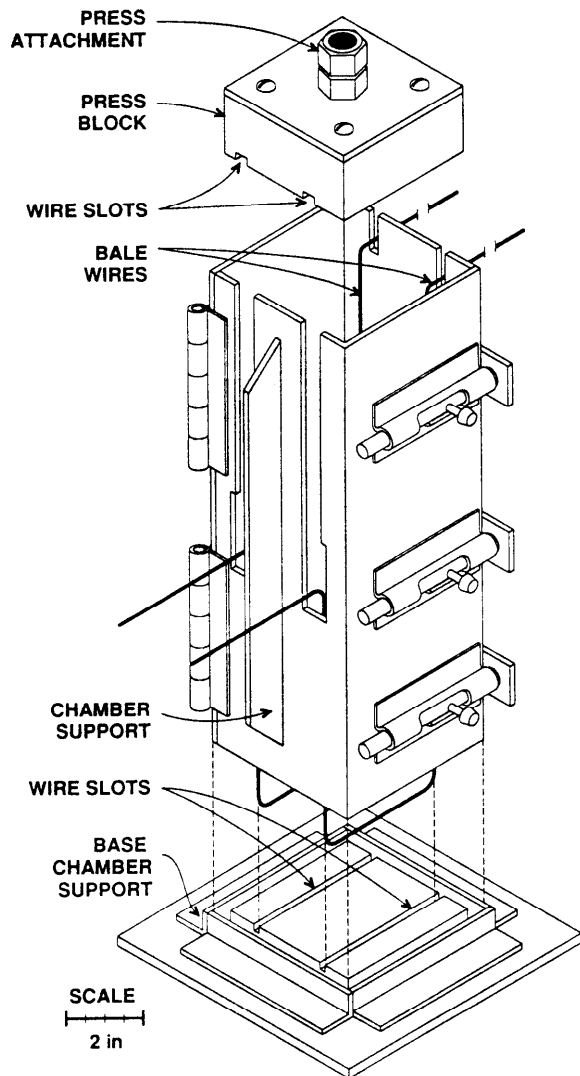

Figure 1. Scaled Drawing of the Laboratory Baling System

Bale Formation. To distribute forage evenly throughout the bale, forage is cut to approximately 4 inches, using a 24 x 24 in. paper cutter. We found it feasible to initially bale the hay in the field with a conventional, small, rectangular baler and then break down selected conventional bales to supply material to make the laboratory-scale bales. The paper cutter was large enough to handle an entire conventional bale flake at one time, eliminating the need to manually tear the flake apart and induce subsequent leaf shatter.

Prior to packing, tie wires are inserted into the bale chamber as shown in Figure 1. The forage is then packed into the bale chamber by hand and hydraulically pressed, so that it remains compressed in the chamber. For high density bales, the bale chamber needs to be hand-packed to capacity, hydraulically pressed, then hand-packed and hydraulically pressed again, until all the desired forage is in the bale chamber. The press block is then removed from the chamber, and the long ends of the tie wires are folded over the compressed forage. The forage is again compressed, this time down to the desired bale length. At this point, the pressure is released slightly so the slack can be pulled out of the tie wires. The forage is then compressed to the desired endpoint, where the long and short wire ends are tied with pliers. The bale chamber is removed from the base, and the chamber is opened, releasing the tied bale. Excess wire from the ties can be clipped as necessary.

Density Adjustment. Density is controlled by maintaining a constant bale volume and varying the amount of plant material placed into the bale chamber. Therefore, it was necessary to establish an average, laboratory-scale bale size. Preliminary studies were conducted on second-cutting alfalfa harvested at one-tenth bloom. Ninety bales with DM content between 65 and 80% averaged $4.05 \pm .08$ in. high and $4.27 \pm .08$ in. wide after they emerged from the bale chamber. The average area of the butt end of the bale was then calculated to be 17.24 in.^2 . Bale length was controlled by marking a line on the bale chamber at the desired length, hydraulically compressing the plant material to that line, and then tying the bale. Our preliminary studies showed that bales averaged $5.27 \pm .16$ in. when the line was drawn 5.75 in. from the bottom of the bale chamber, resulting in an average bale volume of $91.0 \pm 4.4 \text{ in.}^3$. The variability in bale length could undoubtedly be reduced by placing a stop in the pressing mechanism or by positioning the bale chamber such that the desired bale length is obtained when the press stroke is exhausted. These options would reduce reliance on the precision of the press operator, but would also limit flexibility in bale length. The upper density limit we achieved was about 50 lb/ft^3 , but

higher densities could be reached with a higher capacity press. The limit was not due to the strength of the bale chamber.

Results and Discussion

A comparison of densities of the conventional, small, rectangular, alfalfa bales (approximately 15 x 18 x 37 in.) and laboratory bales is shown in Figure 2. At each density, three conventional bales were made from the same windrow of alfalfa using a New Holland Hayliner 273 wire tie baler. These bales were weighed and measured to compute their average density. Then one conventional bale was opened so that laboratory-scale bales could be made from the same alfalfa source. At least two laboratory bales were made to correspond to the average density of the three conventional bales.

This procedure was repeated 39 times over moisture levels from 15 to 36% and conventional bale densities from 10 to 25 lb/ft³. Conventional bale densities were varied by changing the tension on the bale chamber. Laboratory bale densities were then regressed against conventional bale densities. Excellent agreement in density occurred between the two bale sizes; however, hay bales of any size are quite difficult to measure precisely, particularly in regard to length. The difficulty in making precise measurements undoubtedly contributed to the variability in the data. We have found that the most dense bales are the easiest to make. Lower density bales can be made, but some practice might be required to consistently do a satisfactory job.

This system provides a very simple way to simulate, on a small scale, a field-tied hay bale. The baler is both easy to use and relatively inexpensive. Materials for constructing the unit can be purchased for approximately \$50.

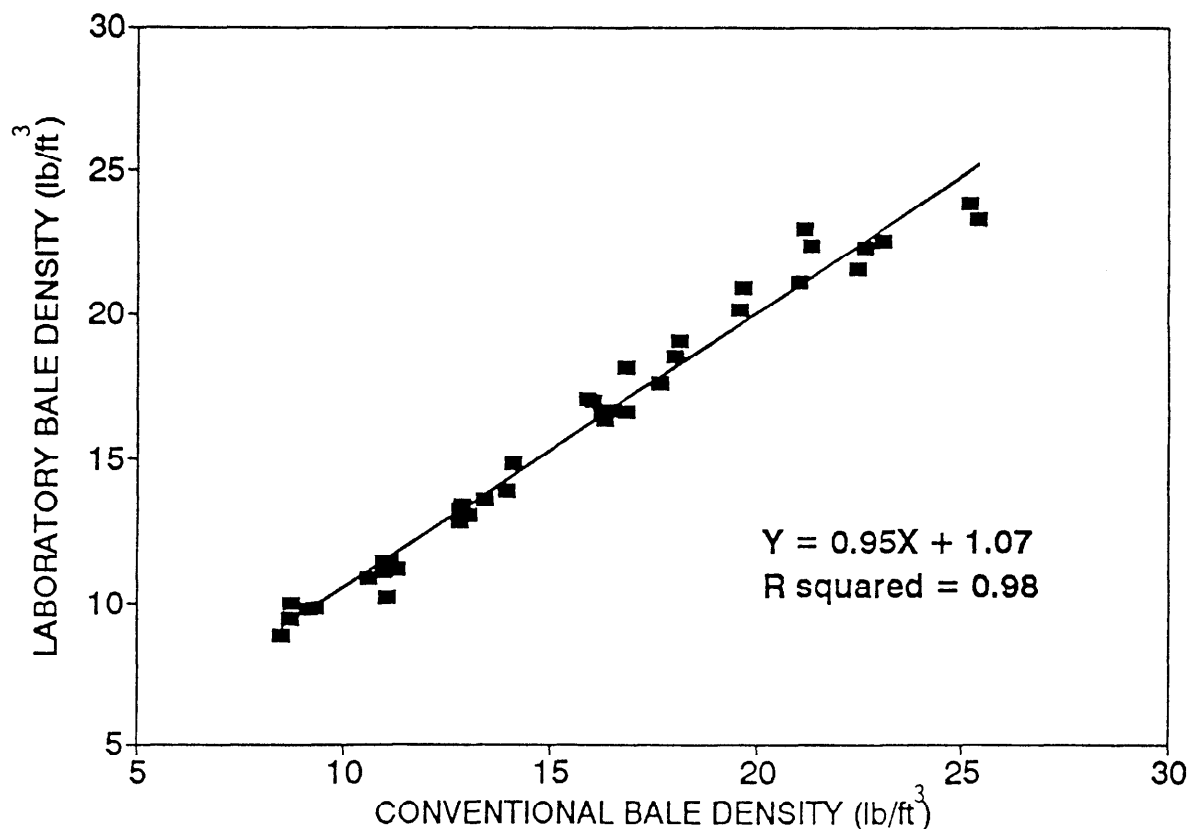

Figure 2. Relationship between Laboratory-scale and Conventional Alfalfa Bale Densities. The Standard Error of the Slope (s_b) = .024

COMPARISON OF CONVENTIONAL AND LABORATORY-SCALE ALFALFA HAY BALES IN SMALL HAYSTACKS¹

W. K. Coblenz², J. O. Fritz², and K. K. Bolsen

Summary

A system for making laboratory-scale alfalfa hay bales was evaluated in two trials. In the first, conventional rectangular and laboratory-scale bales were made at each of seven different combinations of moisture and density. Laboratory bales were incubated between two parent conventional bales of identical moisture content and bale density. Laboratory bales remained different ($P < .05$) from parent conventional bales for most temperature-related storage traits. Agreement between bale types was better for most quality traits.

To achieve closer agreement between bale types, a second experiment was conducted in which the laboratory bales were made at 1.0, 1.3, 1.6, and 2.0 times the density of the conventional bales. Agreement improved between laboratory bales of higher densities and conventional bales for most temperature traits. High-density laboratory bales had significantly greater acid detergent insoluble nitrogen values than conventional bales, particularly at the highest moisture level. These results implicate bale density as an important factor in heat damage to proteins in alfalfa hay.

(Key Words: Hay, Alfalfa, Bale, Protein, Density.)

Introduction

Baling higher moisture alfalfa hay has been a topic of considerable interest for several years. However, the unpredictability of moisture content within and across alfalfa swaths, variability in ambient storage temperatures during different seasons of the year, and difficulty in controlling bale densities all contribute to the frustrating nature of alfalfa hay research. To help address these concerns, a simple system for making wire-tied, laboratory-scale hay bales was developed and is described on page -- of this report. Two experiments were conducted in 1991 to validate the system as a legitimate tool for hay research. The first experiment compared the performance of laboratory-scale and rectangular alfalfa hay bales in a haystack environment over a wide range of bale moistures and densities. The second experiment determined 1) if increasing laboratory bale densities could equalize heating characteristics between bale types and 2) what effect bale density has on alfalfa hay quality.

Experimental Procedures

Experiment 1. A 2-year-old stand of Germaine WL-3201 alfalfa near Keats, KS was harvested (third cutting) at one-third bloom with a mower-conditioner on July 25, 1991. The forage was mowed in three blocks of eight windrows each and allowed to dry undisturbed until the desired level of moisture was reached.

¹Appreciation is expressed to Gary Harter, Dean Larson, Francois Altidor, Larry Wagner, Roberto Sonon, and Lyle Pfaff for their assistance in conducting this study.

²Department of Agronomy.

One randomly assigned windrow within each block was allocated to one of eight whole plots, which included high- and low-density baling treatments at four different moisture levels. When averaged across both bale density and type, these moisture levels were 30.6, 24.8, 20.3, and 14.3 percent. The low-density treatment at 14.3% moisture was omitted from the experiment.

Three conventional 15 × 18 × 37 in. rectangular bales were made from each whole-plot windrow. One of three conventional bales was weighed, measured for length, and core sampled, then opened to make the laboratory bales. Nontreatment bales were weighed and measured to compute average conventional bale densities.

Treatment bales were opened and flakes were randomly chosen (omitting end flakes) for making the laboratory bales. Bale flakes were placed on a 24-inch paper cutter, where forage was cut to approximately 4 inches to ensure uniform distribution of plant material throughout the laboratory bales. Preweighed amounts of that alfalfa were then used to make 4 × 4 1/4 × 5 1/4 in. laboratory bales of the same density as the field-baled conventional bales.

Two conventional and two laboratory bales from the same whole-plot windrow were then incubated in a single small haystack. Haystacks were stored in an open air building with a concrete floor for 35 days or until internal bale temperatures returned to ambient.

Thermocouples were inserted into the center of conventional bales in the field (one per bale), and initial temperatures recorded. Laboratory bales were fitted with identical thermocouples approximately 1 h after bale formation. Temperatures were recorded at 8 am and 3 pm for the first 15 days of storage and once daily thereafter. Temperature data for laboratory and conventional bales were compared for maximum temperature, 30-day avg temperature, and degree days > 30°C.

After the storage period, conventional bales were weighed and core sampled. Laboratory bales were weighed only. All bales were

opened and visually appraised for mold (1 = good, 5 = poor). Core samples from conventional bales and whole laboratory bales were then dried at 50°C; ground; and analyzed for total N, NDF, ADF, and ADIN. Results were analyzed as a split-plot design with the seven combinations of moisture and density as whole plots and bale type (conventional or laboratory) as subplots.

Experiment 2. A 2-year-old stand of Germaine WL-3171 alfalfa near Keats, KS was harvested (fourth cutting) with a mower-conditioner on October 1, 1991. The stand, cut at bud stage, was approximately 15 inches tall. Rainfall during the regrowth period had been limited. The crop was mowed in nine adjacent windrows. Each of three whole-plot treatments, based on moisture content at the time of baling, was replicated three times. Moisture levels for the three whole-plot treatments (high, medium, and low) were 35.3, 25.4, and 18.2%, respectively, when averaged across bale type. The alfalfa was allowed to dry undisturbed until the desired moisture levels were reached the next day, and three conventional bales were made from each whole-plot windrow. Unlike Experiment 1, there was no attempt to control density, except that the baler was adjusted to produce a solid bale. Because of the drought-stressed, immature nature of the alfalfa, bale densities were somewhat higher than normal. Laboratory bales were made as in Experiment 1, with densities 1.0, 1.3, 1.6, and 2.0 times the avg density of the three parent conventional bales. All bales were incubated in haystacks similar to those in Experiment 1. A split-plot design was used with moisture levels as whole plots and bale type-density combinations as subplots. Because of the onset of freezing storage temperatures in late October, heating and deterioration stopped after about 30 days.

Results and Discussion

Experiment 1. Regardless of treatment, conventional bales consistently maintained higher internal temperatures than laboratory bales. However, temperatures of laboratory bales were much more variable. This was particularly true during the first 25 days of storage, when the laboratory bales were most

likely to be actively generating heat. After approximately 25 days of storage, laboratory bales followed essentially the same temperature pattern as the conventional bales, indicating that heat generation after that time was probably minimal.

Temperature traits are compared in Table 1. The best agreement ($P > .05$) between bale types occurred for maximum temperature, indicating that laboratory bales were capable of generating temperatures similar to those of conventional bales when incubated in a small haystack environment. Comparisons of 30-day avg temperature and degree days $> 30^{\circ}\text{C}$ showed that laboratory bales probably lost heat faster than conventional bales. There was better agreement (data not shown) between bale types for other quality traits.

Experiment 2. The physical bale characteristics are shown in Table 2, and statistical comparisons of treatments for storage temperature traits, in Table 3. Although conventional bales generally maintained higher internal temperatures and probably dominated the stack environment, laboratory bales (as in Experiment 1) maintained comparable internal temperatures and exhibited an independent response with respect to temperature.

The most dense laboratory bales maintained the highest internal temperatures. This was expected, because they contained the most plant material and, thus, the most heat-generating substrate. However, even the most dense laboratory bales within a given moisture level did not reach the temperatures of conventional bales for any of the temperature indices measured ($P < .05$).

With few exceptions, ADF and ADIN fractions and visual mold in laboratory bales increased with bale density, regardless of moisture content (Figure 1), and DM recovery decreased as bale density increased. Significant differences in response to sequentially elevated laboratory bale density were observed in: 1) the low-moisture level with respect to ADF, ADIN, visual mold, and DM recovery; 2) the medium-moisture level with respect to ADF and visual mold; and 3) the high-moisture level with respect to ADF,

ADIN, visual mold, and DM recovery. Frequently, high-density laboratory bales had significantly higher NDF and ADIN contents than conventional bales. This occurred specifically for NDF content at the high- and low-moisture levels (data not shown) and ADIN content at the high-moisture level. Visual mold responses followed a similar pattern; the 2.0 density factor laboratory bales had higher visual mold scores than conventional bales in the high- and medium-moisture treatments.

The response of ADIN content in laboratory bales to increasing density was unexpected based on the temperature data. Effective heating period, temperature, and moisture content have been implicated as factors influencing heat damage in alfalfa hay. ADIN is expected to increase with heating. However, in laboratory bales, ADIN increased despite essentially steady temperatures, especially in the high-moisture treatment. The temperatures we measured were the net result of heat production from metabolic activity in plant material, heat moving to the laboratory bales from the conventional bales, and heat dissipation to the bale surface and the environment. Differentiation between these heat sources and transfers might be necessary to adequately explain our results.

Our results suggest several possible mechanisms acting independently or in concert; 1) ADIN values might have increased in response to laboratory bale density because of increases in self-generated heat; 2) self-generated heat and heat imposed from adjacent conventional bales might have impacted ADIN values differently during the storage period; and 3) sequential increases in laboratory bale density at a given moisture level might have rendered alfalfa proteins more susceptible to the Maillard reaction (non-enzymatic browning), even though temperatures in these bales were not significantly different. The last explanation, to our knowledge, has not been previously suggested.

Table 1. Temperature Traits for Conventional and Laboratory Hay Bales Made at Seven Combinations of Moisture and Density in Experiment 1

Moisture, %	Density, lb/ft ³	Bale type ¹	Temperature, °C		
			Maximum	30-day avg	Degree days, > 30°C
30.6	High, 21.4	C	54.9	44.3	525
		L	53.1	41.4	408
30.6	Low, 16.8	C	53.7	41.9	439
		L	51.2	38.2	293
24.8	High, 17.6	C	49.9	41.2	383
		L	49.0	40.3	344
24.8	Low, 13.5	C	50.6	38.7	279
		L	46.7	36.2	204
20.3	High, 11.9	C	45.0	32.7	115
		L	41.3	31.3	82
20.3	Low, 8.9	C	39.8	28.5	33
		L	34.8	26.9	11
14.3	High, 10.5	C	32.4	25.8	3
		L	31.7	25.3	2
LSD (P < .05) ²			3.3	1.1	29

¹C = conventional and L = laboratory.

²LSD values are for comparison of subplot (bale type) means within whole plots (moisture/density level combinations).

Table 2. Description of Treatments and Physical Characteristics of Alfalfa Bales Used in Experiment 2 (Bale wire weights are excluded from all calculations of weight and density involving laboratory bales)

Bale type	Density factor ¹	Moisture, %	Fresh bale wt. lb	Volume ² , ft ³	Estimated density, lb/ft ³
High moisture					
Conventional	---	35.3	142	5.79	24.6
Laboratory	1.00		1.29	.0526	24.5
Laboratory	1.33		1.72		32.8
Laboratory	1.67		2.15		40.9
Laboratory	2.00		2.60		49.4
Medium moisture					
Conventional	---	25.4	122	5.55	22.1
Laboratory	1.00		1.15	.0526	21.8
Laboratory	1.33		1.54		29.3
Laboratory	1.67		1.97		37.5
Laboratory	2.00		2.35		44.8
Low moisture					
Conventional	---	18.2	88	5.40	16.3
Laboratory	1.00		.84	.0526	16.0
Laboratory	1.33		1.13		21.6
Laboratory	1.67		1.41		26.8
Laboratory	2.00		1.75		33.2

¹Theoretical quotient of laboratory bale density divided by conventional bale density.

²Based on a predetermined avg laboratory bale volume of .0526 ft³.

Table 3. Temperature Traits for Conventional and Laboratory Alfalfa Bales Made at Three Moisture Levels in Experiment 2

Moisture level ¹	Bale type	Density factor ²	Temperature, °C		
			Maximum	30-day avg	Degree days > 30°C
High	Conventional	---	57.1	51.0	643
	Laboratory	1.00	54.7	48.1	546
	Laboratory	1.33	55.4	48.7	564
	Laboratory	1.67	55.5	48.8	569
	Laboratory	2.00	55.8	49.2	580
Medium	Conventional	---	51.0	36.4	263
	Laboratory	1.00	48.5	36.2	258
	Laboratory	1.33	47.8	36.1	253
	Laboratory	1.67	49.7	36.9	278
	Laboratory	2.00	48.6	36.9	273
LOW	Conventional	---	46.2	25.8	101
	Laboratory	1.00	42.6	23.6	61
	Laboratory	1.33	42.6	24.1	63
	Laboratory	1.67	43.6	24.6	75
	Laboratory	2.00	44.6	25.8	93
LSD (P < .05) ³			1.4	1.6	44

¹Moisture level designations of high, medium, and low correspond to moisture contents of 35.3, 25.4, and 18.2%, respectively, when averaged across bale type.

²Theoretical quotient of laboratory bale density divided by conventional bale density.

³LSD values are for comparisons of subplot means within whole plots (moisture levels).

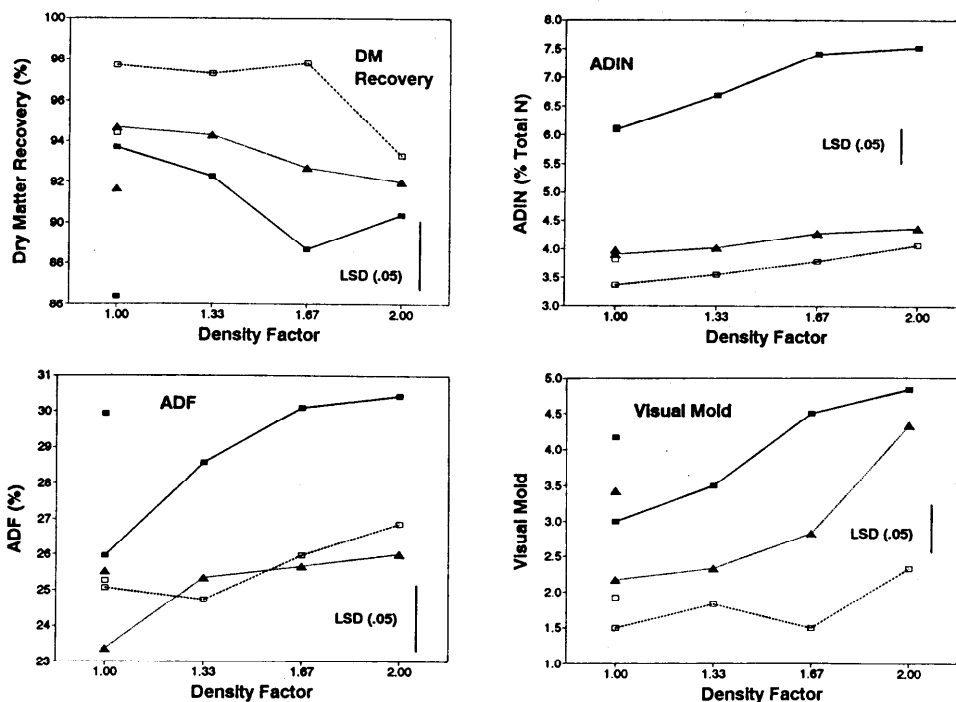

Figure 1. Quality Traits for Conventional and Laboratory Alfalfa Hay Bales in Experiment 2; where □ = Low Moisture, ▲ = Medium Moisture, and ■ = High Moisture; Markers Alone = Conventional Bales, Markers Connected by Lines = Laboratory Bales; and Visual Mold Score 1.0 = Good, 5.0 = Poor

STORAGE LOSSES IN NET-WRAPPED, LARGE, ROUND BALES OF ALFALFA HAY^{1,2}

*R. K. Taylor³, D. A. Blas⁴, D. L. Kueck⁵,
T. M. Maxwell⁵, C. E. Addison⁵, and J. P. Shroyer⁶*

Summary

Net- and twine-wrapped alfalfa hay bales were stored from July, 1990 to April, 1991 in three Kansas counties (Reno, Saline, and Stafford). Dry matter losses and changes in acid detergent fiber and acid detergent insoluble nitrogen levels during storage were not significantly different between net- and twine-wrapped bales. Although a significant difference in dry matter recovery between inside and outside bale storage occurred in Saline County, it was not considered important because all recoveries were high. No significant differences in ADF or ADIN increases were found between initial core samples and samples from the outer 4 in. of the bales at the end of storage. The minimal deterioration and weathering were probably due to below average rainfall (less than 14 in.) during the 9-mon. storage period. Net wrapping is probably not justified on the basis of reducing storage losses in low rainfall areas.

(Key Words: Alfalfa, Hay, Round Bales, Storage.)

Introduction

Large round bales are a popular hay packaging system because of high capacities, and the fact that they can be handled by one person. Because bales are typically stored outside, the cost of owning a storage structure is eliminated. However, round bales are not easily stacked, so long distance transportation and inside storage are not as efficient as with square bales.

Net or mesh wrapping of large round bales is becoming a popular alternative to twine tying. It takes less time to apply, so baler capacity is increased. In addition, net-wrapped bales appear better contained with a smoother exterior, which should improve transportability and minimize rainfall penetration. Our objective was to determine the effects of net wrap and plastic twine on preservation of quality of large round bales of alfalfa hay during storage.

¹Appreciation is expressed to C.K. Ranch, Brookville; Spare Farms, St. John; and Tom Beal, Hutchinson for cooperating in this study.

²Appreciation is expressed to John Deere Ottumwa Works, Ottumwa, IA for the use of a baler and Exxon Chemical, Kingman for supplying net wrap.

³Department of Agricultural Engineering.

⁴Extension Livestock Specialist, South Central Kansas.

⁵Extension Agent, Agriculture in Reno, Saline, and Stafford counties, respectively.

⁶Department of Agronomy.

of each wrapping material were stored either inside or outside. Inside storage was not available in Stafford County, so bales were placed on pallets and covered with a plastic tarp. Each bale was weighed and core sampled before storage. Bales stored outside were stacked tightly, end-to-end in north-south rows in a well drained area with approximately 6 ft between rows.

Bales were removed from storage in April, 1991 and were weighed and core sampled. In addition, all bales stored outside were sampled to a depth of 4 in. from the surface on the sides and top.

Results and Discussion

The precipitation in all three counties was below average for the storage period. Table 1 lists the DM recovery, average initial moisture content, and initial and final ADF and ADIN levels. There were no significant

differences in DM recovery among wrapping treatments for individual counties. A statistical difference between storage method was found in Saline County ($P < .05$). However, it was of little practical significance, because all DM recoveries were high.

Although no interaction or significant differences in ADF changes were found among treatments ($P > .05$), ADF increases were generally greater for twine-wrapped bales stored outside than their net-wrapped counterparts. No interactions or significant differences among treatments were found for ADIN changes.

The bales stored outside were also compared based on samples taken from the outer 4 inches. No significant differences in ADF or ADIN were found between wrapping materials in any county. No significant differences were found in ADIN levels between wrapping materials.

Table 1. Dry Matter Recovery, Initial Moisture Content, and Chemical Composition of the Alfalfa Stored in Each County

county	Bale wrap	Storage	DM recovery ^a	Initial moisture, %	ADF			ADIN		
					initial core	final core	final 4 in.	initial core	final core	final 4 in.
					————— % of the hay DM —————					
Reno	Net	Inside	95.8	21.4	37.7	37.5		1.35	1.58	
		Outside	95.4	21.6	35.6	36.3	39.1	1.31	1.57	1.37
	Twine	Inside	94.7	19.6	37.6	39.1		1.16	1.43	
		Outside	96.9	20.5	37.7	39.4	39.9	1.21	1.88	1.58
Saline	Net	Inside	99.9	9.6	30.6	32.3		.89	1.21	
		Outside	97.9	9.6	34.4	35.0	37.0	1.03	1.28	1.35
	Twine	Inside	99.8	8.8	32.6	34.0		.98	1.05	
		Outside	97.6	8.5	32.1	33.7	36.4	1.03	1.18	1.31
Stafford	Net	Inside	99.2	11.9	28.7	30.7		.77	.77	
		Outside	98.3	11.4	30.0	32.0	33.5	30	1.24	1.06
	Twine	Inside	98.9	12.3	26.1	27.0		.70	.68	
		Outside	99.2	12.7	27.3	29.8	30.7	.81	.92	1.10

^aAs a % of the initial hale wt (DM basis).

PRESERVATION OF ALFALFA HAY WITH A MICROBIAL INOCULANT¹

***R. K. Taylor², D. A. Blas³, W. C. Mahanna⁴,
T. M. Maxwell⁵, and J. P. Shroyer⁶***

Summary

Eleven large, round, alfalfa bales were treated with Pioneer® Brand 1155 Alfalfa Hay Inoculant and nine bales were untreated. The initial baling moistures were 14.1% (low) or 17.6% (medium). No significant differences were found in dry matter recovery or changes in acid detergent fiber, neutral detergent fiber, and acid detergent insoluble nitrogen levels during the 2-month storage period. Average temperature was highest in the medium moisture bales, but was not high enough to cause heat damage. The microbial inoculant did not improve preservation or quality of the alfalfa hay at the baling moistures used in this study.

(Key Words: Alfalfa, Hay Preservation, Round Bales, Inoculant.)

Introduction

The feeding value of alfalfa is a complex interaction between growing season, plant maturity at harvest, harvest conditions, and

storage environment. Of these, alfalfa quality is most vulnerable to conditions at harvest. For consistent production of high quality hay, producers must harvest within a narrow window of moisture content to minimize leaf loss in the field or quality deterioration through heating in storage. Various hay preservatives have been developed and promoted to prevent excessive heat production, mold growth, color changes, and nutrient loss in hay baled at higher moisture. Our objective was to evaluate a microbial inoculant applied to large round bales of alfalfa hay.

Experimental Procedures

The first cutting of a 7-yr-old alfalfa stand was baled in May, 1991 with a John Deere 435 large round baler. Baling started at about 4:30 p.m. and concluded by 8:30 p.m. Moisture varied from the top of the windrow to the bottom and along the length of the windrow. The baler was equipped with a tank, electric pump and two flood jet nozzles. Pioneer® Brand 1155 Alfalfa Hay Inoculant was applied at the recommended rate as the forage entered

¹Appreciation is expressed to Ade's Alfalfa Farm, Gypsum, Kansas, for cooperating in this study and to Pioneer Hi-Bred International, Inc., Microbial Genetics Division, West Des Moines, Iowa, for partial funding.

²Department of Agricultural Engineering.

³Extension Livestock Specialist, South Central Kansas.

⁴Technical Services Nutritionist, Pioneer Hi-Bred International, Inc.

⁵Extension Agent, Agriculture, Saline County.

⁶Department of Agronomy.

the throat of the baler. There were 11 inoculated bales and nine untreated (control) bales.

Each bale was weighed and core sampled in multiple locations immediately after baling and placed individually on pallets at the storage site. Two thermocouples were inserted into each bale, and temperatures were automatically monitored every 6 hours for a period of 2 months. At the end of storage, each bale was weighed and core sampled in multiple locations.

Samples were analyzed for moisture content, crude protein (CP), acid detergent fiber (ADF), neutral detergent fiber (NDF), and acid detergent insoluble nitrogen (ADIN).

Results and Discussion

Initial and final chemical composition and DM recovery of the control and inoculated hays are shown in Table 1. Actual hay moisture contents at baling were lower than targeted, and there were no significant differ-

ences ($P > .10$) in either DM recovery or changes in chemical composition among the hay treatments. As expected for a 2-month storage period, DM recovery was high for all treatments. Acid detergent insoluble nitrogen remained low, because heating was insufficient to bind protein to the cell wall. The ADF fraction increased numerically for all treatments, except the low moisture control, and NDF values increased by comparable amounts for all treatments.

Temperatures for all treatments peaked at approximately 12 to 14 days after baling (data not shown). The peak temperature was about 111°F for both the control and inoculated, medium moisture hays. As expected, the low moisture bales had lower temperatures than medium moisture bales. There was considerable variation in bale temperatures within hay treatments, but maximum, average, peak temperature for all individual bales was below 122°F. However, there was as much as a 59°F difference between two thermocouples within some bales. This indicates that "hot spots" existed within bales, and these were likely due to variation in windrow moisture.

Table 1. Initial and Final Chemical Composition and DM Recovery of the Four Alfalfa Hays

Item ^a	Control				Inoculated			
	Low moisture		Medium moisture		Low moisture		Medium moisture	
	Initial	Final	Initial	Final	Initial	Final	Initial	Final
Moisture, %	14.2	10.1	17.5	10.9	14.0	10.5	17.7	10.8
DM recovery ^b	---	97.2	---	97.2	---	96.8	---	97.8
CP	20.7	21.2	20.8	20.7	20.9	21.2	21.0	21.3
ADF	28.9	28.5	28.4	29.5	27.8	29.1	29.2	29.6
NDF	38.3	39.6	38.8	41.8	36.9	39.8	39.4	42.3
ADIN	.48	.43	.53	.37	.51	.40	.40	.34

^aCP = crude protein, ADF = acid detergent fiber, NDF = neutral detergent fiber, ACP = available crude protein, and ADIN = acid detergent insoluble nitrogen.

^bAs a % of initial bale wt (DM basis).

SUMMER ANNUAL FORAGES IN SOUTH CENTRAL KANSAS

W. F. Heer¹, D. A. Blas², and D. L. Fjell³

Summary

Six summer annuals and three forage sorghums were evaluated for forage yield and quality under south central Kansas dryland conditions. When cut in the late boot to early heading stage, all forage types (millet, sudan, sorghum-sudan, and forage sorghum) produced similar dry matter yields, with no consistent differences in nutritional quality. Allowing the forages to reach maturity prior to cutting increased total yield per acre but decreased the crude protein content. The millets were higher in protein at maturity than the sudans or forage sorghums. However, the forage sorghums produced the most mature forage, whereas common sudan yielded the least. Cool, moist conditions during the growing season allowed the forages to develop slowly.

(Key Words: Summer Annuals, Forage Sorghum, Yield, Forage Quality, Nitrate.)

Introduction

Summer annual forages offer Kansas livestock producers flexibility either as substitutes for perennial warm-season grasses in complementary forage grazing systems or as hedges for harvested forage during periods of low rainfall. Because summer annual forage types and cultivars have different growth characteristics, it is important that summer

annual selection be based on intended use (grazing, haying, or silage). This study compared the yield and nutritional quality of six summer annuals and three forage sorghums.

Experimental Procedures

Field plots were established on the South Central Kansas Experiment Field in June of 1992. The plot area received a broadcast application of 91 lbs nitrogen and 40 lbs phosphate incorporated 2 to 4 inches deep with a field cultivator. Two side-by-side sets of the nine forages were planted on June 15 in four replications of 5 by 30 ft plots. The forage types evaluated included three millets, two sudans, one sorghum-sudan, and three forage sorghum hybrids. A modified KEM plot drill with a belt cone metering device was used to seed the forages about 3/4 inch deep in randomly assigned plots at 15 lbs per acre in 8-inch rows. One set of plots was harvested at the late boot to early heading stage and the regrowth was cut at first frost. The second set of plots was harvested at grain maturity.

The agronomic data collected for each plot included stage of maturity, plant height, and dry matter yield. At each harvest, forage samples were collected and sent to Peterson Laboratories, Inc. in Hutchinson, Kansas and analyzed for crude protein, acid detergent fiber (ADF), nitrate, and prussic acid. The

¹Agronomist-in-Charge, South Central Kansas Experiment Field.

²Extension Livestock Specialist, South Central Kansas.

³KSU Extension Crop Specialist.

plots were harvested using a Carter forage harvester set to a cutting height of 6 to 7 inches.

Results and Discussion

Yield and forage quality results for the two sets of six summer annuals and three forage sorghum are shown in Table 1. The vegetatively cut plots were harvested on August 17, and the regrowth was cut on October 23. The second set of plots cut at grain maturity was harvested on September 17. The growing season in 1992 was considerably better than that of 1990, when the forage yield and quality in a similar study (1991 Cattlemen's Day Rept. of Prog. 623) were affected by abnormally dry, hot conditions. The 1992 growing season was cool and moist, allowing for excellent forage production.

Average dry matter yields at the vegetative cutting stage were similar across forage (millet, sudan, sorghum-sudan, and forage sorghum) types. However, cultivar differences were observed, with common sudan, German foxtail millet, and FF 555 forage sorghum having the lowest vegetative yields. When cut in the vegetative state, no consistent differences in crude protein, fiber, nitrate, or prussic acid were noted across forage types.

When cut at grain maturity, the forage sorghums had the highest dry matter yields, and common sudan had the lowest yield. The pearl and foxtail millets tended to be higher in crude protein at maturity. In general, those cultivars that tended to have higher leaf to stem ratios also had higher crude protein levels. This is consistent with previous work in Kansas. Forage nitrate levels were quite high in spite of advanced plant maturity in several cultivars. Prussic acid (cyanide) was very low in all cultivars at all cutting stages.

Two summer annuals, Haygrazer sorghum-sudan and Trudan 8 sudan, had the highest regrowth potential. Millet regrowth was surprisingly low. Indeed, there was insufficient regrowth of 404 GM pearl millet and German foxtail millet for harvest. The regrowth of all forage types was substantially lower in protein, fiber, and nitrate than vegetative or mature cuttings. However, Tifleaf pearl millet regrowth contained much more nitrate than other cultivars harvested.

The variation in forage yield and quality of the summer annuals utilized in this study emphasizes the importance of cultivar selection based on intended use for grazing, hay, or silage.

Table 1. Yield and Nutritional Quality of Summer Annual Forages in 1992

Cultivar ¹	Plant height	Dry matter	DM yield	Nitrate (NO ₃)	Prussic acid	Crude protein	ADF ²
	inches	%	ton/A	----- PPM -----	-----	----- % -----	
----- Vegetative Cutting -----							
Common Sudan	78	26.0	3.22	3525	7.5	9.1	44
GM 404 HPM	81	18.1	4.36	7300	4.3	8.7	43
German Millet FM	44	23.6	3.59	3925	4.5	9.4	41
Haygrazer SS	103	21.8	4.30	6850	6.8	10.1	41
Tifleaf HPM	46	18.3	4.17	4130	4.8	11.5	39
Trudan 8 Sudan	106	20.4	4.21	6600	5.5	8.4	41
Silomaker FS	79	16.2	4.43	7225	8.3	8.2	42
Milk-A-Lot FS	69	18.1	4.28	9075	14.8	11.0	39
FF 555 FS	86	15.0	3.56	7900	4.8	8.5	41
LSD ³	6.8	.02	.8	5430	3.7	2.0	2
% CV ⁴	6	8	13	59	38	15	4
----- Regrowth Cutting -----							
Common Sudan	49	46.5	1.58	511	11.8	4.6	18
GM 404 HPM	---	---	---	---	---	---	---
German Millet FM	---	---	---	---	---	---	---
Haygrazer SS	47	27.0	2.70	726	17.3	3.2	9
Tifleaf HPM	16	60.3	.78	4855	21.0	8.0	25
Trudan 8 Sudan	39	28.0	2.43	722	24.3	3.3	10
Silomaker FS	34	27.1	1.95	633	28.8	3.1	10
Milk-A-Lot FS	30	29.5	2.08	779	29.3	4.0	10
FF 555 FS	34	27.3	1.49	840	16.8	3.3	9
LSD ³	7	.05	.42	1260	15	.8	3
% CV ⁴	13	10	15	65	47	12	16
----- Mature Cutting -----							
Common Sudan	82	43.8	3.39	3725	7.5	6.1	49
GM 404 HPM	94	41.4	5.98	12450	13.3	8.2	45
German Millet FM	49	58.9	4.76	9125	9.5	8.6	42
Haygrazer SS	104	37.6	6.28	4650	11.8	5.8	44
Tifleaf HPM	64	34.8	7.01	12900	10.5	9.2	42
Trudan 8 Sudan	106	43.7	6.89	7850	10.8	6.9	42
Silomaker FS	90	32.0	8.59	9250	20.8	6.0	40
Milk-A-Lot FS	76	33.9	7.86	15150	18.5	7.5	44
FF 555 FS	107	33.3	8.48	6100	13.8	6.8	35
LSD ³	6.3	.04	1.26	8911	5.8	1.4	3
% CV ⁴	5	6	13	68	31	13	5

¹HPM = hybrid pearl millet; FM = foxtail millet; SS = sorghum × sudan; FS = forage sorghum.

²ADF = acid detergent fiber.

³LSD = least significant difference (P < .05).

⁴CV = coefficient of variation among cultivars.

⁵Insufficient regrowth for harvest.

LARGE ROUND BALE HAY WASTAGE BY VARIOUS FEEDING METHODS^{1,2}

*D. A. Blas³, R. K. Taylor⁴, G. W. Warmann⁵,
B. M. Plaschka⁶, and G. E. Newdigger⁶*

Summary

The amounts of wheat or hybrid sudan hay wasted with three large round bale feeding methods were evaluated at two ranch locations. The feeding methods were: 1) bale processor (Hay Forage Industries BP 25[®]) used to shred forage into bunks; 2) the same processor used to shred forage onto the ground; and 3) unrolling large round bales on the ground. Estimated forage wastages or refusals from unrolling, shredding onto ground, and shredding into bunks were 23, 13, and 8% with wheat hay and 22, 16, and 11% with sudan hay, respectively. These results demonstrate the potential for substantial savings of forage. Shredding or tub-grinding large round bales and feeding in bunks appears to have economic potential when hay prices are high and when herd size is large.

(Key Words: Feeding Management, Feed Wastage, Large Round Bales.)

Introduction

Wastage is expected in any hay feeding system, with the amount of loss varying with the particular hay package and feeding system used. Factors that contribute to wastage include forage trampling, leaf shatter, chemical and physical deterioration, and manure contamination. Because few appropriate estimates exist, our objective was to document hay wastage and refusal with three different feeding methods and determine the potential savings.

Experimental Procedures

Large round bales (12 per location) of wheat or hybrid sudan hay were identified and weighed prior to feeding at two producer locations in Kansas. Cows were uniformly allotted to three groups and fed 1) hay shredded (BP 25[®] Bale Processor) into bunks, 2) hay processed as in treatment 1, but placed on the ground, and 3) large, round hay bales unrolled on the ground. Cattle numbers were adjusted across treatments to provide similar hay allowances among treatments. Twenty-

¹Appreciation is expressed to Hay Forage Industries, Hesston, KS for use of a BP 25 Large Round Bale Processor.

²Appreciation is expressed to Jack Janssen, Geneseo, KS and to Jim Colborn, Medicine Lodge, KS for providing cattle, equipment, and assistance.

³Extension Livestock Specialist, South Central Kansas.

⁴KSU Extension Farm Power and Machinery Specialist.

⁵Extension Agricultural Economist, South Central Kansas.

⁶Extension Agricultural Agents in Ellsworth and Barber counties, respectively.

four hours after each feeding, all remaining forage around bunks was manually gathered and weighed. For the other two treatments (hay shredded or unrolled on the ground), the length of the forage row was measured. Then, wasted hay in three or four 5-yard-long segments was gathered and weighed to calculate an estimate of wastage from the entire bale. Wastage estimates for all treatments were repeated daily for 4 days at each location. The dry matter content of gathered subsamples was determined to correct for moisture variation across treatments and day of sampling.

Results and Discussion

There was considerable daily variation in forage wastage within feeding methods for both forage types (Table 1). Wheat hay shredded into bunks resulted in less forage waste than unrolling large round bales ($P < .10$). Simply unrolling large round bales resulted in 22 to 23% feeding wastage with the two forages. In contrast, shredding bales onto the ground or into feed bunks reduced wastage to 13 and 8% with wheat hay and to 16 and 11% with hybrid sudan, respectively.

Does the feed saved more than pay for the additional costs of shredding and feeding in bunks? An economic evaluation of the machine and bunk costs was compared with

the value of hay saved through bunk feeding. Bunk space requirements were estimated at 1 foot per cow and at a cost of \$2.00 per foot, annualized over 5 years at 10% interest. Machine ownership costs for the BP 25 hay processor used in this study were estimated using the format illustrated in Figure 1. Under the assumptions used in the figure, the hay processor would cost about \$17 per hour when used 150 hours yearly, or about \$6 per ton of hay processed. By comparison, custom rates for rental of a tub grinder reported in *Kansas Custom Rates 1991* averaged \$57.72 per hour based on 48 reports. Common grinding charges run \$6 to 10 per ton; however, most custom operators charge by the hour.

A partial budget used to evaluate the economics of processing hay and feeding is shown in Figure 2. The results of nine such analyses evaluating three hay types and three herd sizes are shown in Table 2. The potential savings of bunk feeding processed forage depends on hay price, expected reduction in hay wastage, and herd size.

Grinding hay and feeding in bunks have an economic payoff when feed values are higher and when herd size is larger. Calculated net savings were positive for grinding and bunk feeding wheat hay to a 300-head cow herd and for higher priced emergency hay during forage shortages for herds over 200 head.

Table 1. Large Round Bale Forage Wastage by Feeding Method and Hay Type

Forage type	Feeding method ^a			LSD ^b
	Proc/bunk	Proc/ground	Unrolled	
Wheat hay:				
% refused or wasted				
Average	8 ^b	13 ^{bc}	23 ^c	9.5
Range	3 - 12	5 - 20	10 - 32	
Lb forage DM offered/cow	22.3	21.2	24.6	
Hybrid sudan hay:				
% refused or wasted				
Average	11	16	22	11.0
Range	7 - 15	7 - 31	10 - 31	
Lb forage DM offered/cow	20.1	20.8	19.9	

^aProc/bunk and Proc/ground = forage fed with large round bale processor in bunk and on ground, respectively; Unrolled = forage bale unrolled on the ground.

^bLSD = least significant difference.

^{c,d}Means in the same row with unlike letters differ ($P < .10$).

Table 2. Net Savings from Processing Hay and Feeding in Bunks—Three Hay Types and Three Herd Sizes

Hay type (value)	Herd size		
	100 Head	200 Head	300 Head
Sudan hay ^a (\$45/ton)	-\$1,493.17	-\$994.34	-\$633.52
Wheat hay ^b (\$50/ton)	-\$1,126.76	-\$261.51	\$465.72
Emergency hay ^b (\$75/ton)	-\$597.26	\$797.49	\$2,054.22

^a11% feed waste reduction.

^b15% feed waste reduction.

Figure 1

Annual Machine Cost for <u>Bale Processor</u>	
Purchase cost of model tested	<u>\$12,241.00</u>
This machine will last <u>10</u> years and is used <u>150</u> hours per year.	
Annual depreciation (20% salvage value)	<u>\$ 979.28</u>
Annual interest on investment (6%)	<u>\$ 734.46</u>
Fuel use	<u>\$ --</u>
Estimated repairs (initial cost × hours use × repair factor)	<u>\$ 840.00</u>
TOTAL ANNUAL COST	<u>\$ 2,553.74</u>
Total cost per hour for <u>150</u> hours per year	<u>\$ 17.02</u>
NOTES: Comparative custom rates: avg. rental of tub grinder = \$57.72/h based on 48 reports in <i>Kansas Custom Rates 1991</i> .	

Figure 2

Partial Budget Worksheet	
Alternative under consideration: <i>Grinding and feeding in bunks for 300-head cow herd—wheat hay @ \$50/ton.</i>	
Added Returns:	
_____	_____
_____	_____
_____	_____
Reduced Costs:	
<u>Less feed costs: savings are</u>	<u>\$3,177.00</u>
<u>15% × 423.6 tons × \$50/ton</u>	_____
_____	_____
(1) Total Added Returns and Reduced Costs	<u>\$3,177.00</u>
Added Costs:	
<u>Annual costs for feed bunks</u>	<u>\$ 158.28</u>
<u>(300 × \$2/ft) = \$600;</u>	_____
<u>5 yr @ 10%; hay processor (150 h) \$2,553.00</u>	_____
Reduced Returns:	
_____	_____
_____	_____
_____	_____
(2) Total Added Costs and Reduced Returns	<u>\$2,711.28</u>
Net Income Change [(1)-(2)]	<u>\$ 465.72</u>
NOTES: Assumed hay fed for 120 d. Trial used 23.53 lb hay on an as-fed basis. Total feed used was estimated to be 300 cows × 23.53 lb/d × 120 d = 423.6 tons of feed.	

EFFECT OF PROTEIN CONCENTRATION IN SUPPLEMENTS AND FREQUENCY OF SUPPLEMENTATION ON THE PERFORMANCE OF BEEF COWS GRAZING DORMANT BLUESTEM RANGE¹

*J.L. Beaty, R.C. Cochran, E.S. Vanzant,
J.L. Morrill, R.T. Brandt, Jr., and D.E. Johnson²*

Summary

One hundred twenty-eight, pregnant, Angus × Hereford cows were used to determine whether response to altering frequency of winter range supplementation depends on the protein concentration in the supplements. Supplements containing 12%, 21%, 31%, or 41% crude protein (CP) were fed either daily (7X) or three times weekly (3X). Both groups consumed 31 lbs of supplement per head weekly. Frequency of supplementation exerted only minor influences on cow performance and had no effect on calf performance. However, cows lost less body weight and condition as CP concentration in the supplement increased. In addition, calf weaning weights were improved with increasing CP in the supplement. In conclusion, the impact of supplement CP concentration was much greater than the impact of alteration in supplementation frequency.

(Key Words: Beef Cows, Winter Range, Frequency, Protein, Supplementation.)

Introduction

In addition to actual supplement costs, winter supplementation involves additional expenses associated with labor and time. Previous research indicates that supplements with high CP concentrations (30 to 40%) may successfully be fed less frequently. However, less frequent feeding of supplements with low

to moderate CP concentration has not been thoroughly evaluated. Our objective was to determine if response to altering frequency of supplementation depends on CP concentration in supplements fed to cows grazing winter range.

Experimental Procedures

One hundred twenty-eight, pregnant, Angus × Hereford cows (average initial body weight = 1047 lb; average initial body condition = 5.2) were assigned to one of four different supplement CP concentrations: 12%, 21%, 31%, or 41% CP, fed at two different frequencies: daily (7X) or three times weekly (3X). Both 7X and 3X groups consumed 31 lbs (dry matter basis) of the respective supplement per head during each week. Supplements were comprised of rolled sorghum grain and soybean meal. A trace mineralized salt/dicalcium phosphate mix was available at all times. At the initiation of the trial, cows received an injection of 1,000,000 IU of vitamin A. Treatment supplements were fed beginning on November 20, 1991 and continued through calving (average calving date = March 4, 1992).

All treatments were equally represented in each of four pastures. Cows were rotated among pastures at monthly intervals. All cows were gathered (by pasture) in the morning, sorted into treatment groups, and group-fed their supplement. On days on which only the

¹The authors would like to thank Gary Ritter, Wayne Adolph, and the student workers at the Range Research Unit for their invaluable assistance in conducting this trial.

²Department of Statistics.

7X treatment groups were fed, cows in the 3X treatment groups were maintained in a pen while the 7X groups consumed their supplement. The order of pastures in which cows were gathered was rotated daily. Grazing time was recorded during a 1-week period in January. Cows within a single pasture were fitted with vibracorders (grazing recorder) and were individually fed during the measurement period. Before each weigh period, (days 0, 58, 86, calving (average 105 days), 166, and 321 of the trial) cows were penned and held off water overnight. Cows were weighed and condition-scored within 48 hours after calving, and then removed from the trial and managed similarly. Cows were pasture-mated to Angus bulls during a 60-day breeding season. Pregnancy was determined by rectal palpation.

Results and Discussion

Response to frequency of supplementation did not depend on the protein concentration in the supplements. Losses in body weight and condition measured at calving were slightly greater for cows supplemented 3X versus 7X ($P \leq .10$; Table 1). Calf birth weights and weaning weights were similar ($P > .10$) regardless of supplementation frequency. Similarly, grazing times and pregnancy rates were not different ($P > .10$) between 7X and 3X supplementation groups. However, all treatment groups were gathered daily in this study in an attempt to concentrate on potential detrimental effects on

ruminal function when supplementation frequency is altered. This may have affected the behavioral patterns of the 3X group. Research is currently underway to evaluate potential behavioral differences in animals on treatments similar to our 3X and 7X treatments.

As supplement CP increased, cows lost less body weight and condition ($P < .01$). Cows offered the 12% CP supplement lost considerable body weight and condition from the start of the trial through calving. However, the magnitude of change in these variables decreased as the CP concentration in the supplement increased above 21%. Calf birth weights tended ($P = .15$) to increase and then level off as CP in the supplement increased. Weaning weights increased ($P = .05$) in direct proportion to increasing CP in the supplement. Grazing time and pregnancy rate were not different ($P > .10$) among the supplements.

Although the numbers of animals available likely limited the ability to detect statistical significance in pregnancy rate, the magnitude of difference between groups fed the 12% and 41% CP supplements warrants careful consideration. Other research reports suggest that prepartum body weight and condition changes of the magnitude observed in those cows receiving the 12% CP supplement would be expected to negatively impact reproductive performance.

Table 1. Effect of Frequency of Supplementation and Protein Concentration in Supplements Offered to Beef Cows Grazing Dormant Bluestem^a

Item	Protein concentrations				SE	P ≤			Frequency ^b		SE	P ≤
	12%	21%	31%	41%		L	Q	C	7X	3X		
Initial BW ^c	1054	1048	1046	1040	15.23	.54	.99	.91	1040	1054	10.77	.37
Initial BC ^d	5.2	5.1	5.2	5.3	.08	.48	.43	.72	5.2	5.2	.06	.77
Calving												
Δ ^e BW	-285.3	-185.8	-132.5	-114.0	6.72	.01	.01	.70	-165.9	-193.0	4.75	.01
Δ BC	-1.97	-1.06	-.78	-.56	.09	.01	.01	.16	-1.02	-1.17	.06	.10
166 d (Breeding)												
Δ BW	-211.9	-171.4	-180.7	-144.9	19.99	.04	.91	.30	-178.0	-176.5	14.14	.94
Δ BC	-1.29	-.81	-.69	-.51	.09	.01	.11	.28	-.79	-.86	.06	.47
321 d (Weaning)												
Δ BW	7.6	24.4	23.6	20.5	8.92	.35	.28	.71	21.94	16.06	6.34	.52
Δ BC	.02	.04	.05	.03	.08	.89	.70	.93	.03	.04	.05	.83
Grazing time, h	7.2	6.6	7.4	6.3	.59	.47	.68	.21	6.8	7.0	.42	.75
PR% ^f	90.3	96.7	93.8	100.0					95.2	95.2		
Calf birth wt	74.2	79.0	80.6	78.6	2.23	.15	.15	.96	77.7	78.5	1.58	.71
Calf WW ^g	491.5	505.2	521.6	523.6	12.38	.05	.64	.76	511.8	509.1	8.76	.83

^aNo frequency × protein interaction (P > .10) on variables presented. SE = standard error, L = linear, Q = quadratic, and C = cubic effects.

^b7X = received supplement daily and 3X received supplement three times weekly.

^cBW = body weight (pounds).

^dBC = body condition (1 = thinnest and 9 = fattest).

^eΔ = change.

^fPR = pregnancy rate. Chi-square analysis indicated no significant differences.

^gWW = weaning weight (pounds).

INFLUENCE OF FREQUENCY OF SUPPLEMENTATION AND PROTEIN CONCENTRATION IN SUPPLEMENTS ON DIGESTION CHARACTERISTICS OF BEEF STEERS OFFERED WHEAT STRAW¹

***J. L. Beaty, R. C. Cochran, B. A. Lintzenich,
E. S. Vanzant, J. L. Morrill, R. T. Brandt, Jr.,
and D. E. Johnson²***

Summary

Eight ruminally cannulated steers were used to determine digestion characteristics of soybean meal/sorghum grain supplements containing 12%, 20%, 30%, or 39% crude protein (CP) fed either daily (7X) or three times weekly (3X). The basal forage was wheat straw. Weekly supplement intake was the same per week (30.5 lb) for both frequency groups. The effect of feeding supplements differing in protein concentration on wheat straw intake and dry matter digestibility (DMD) did not depend on frequency of supplementation. Increased frequency of supplementation resulted in greater intake of straw, although DMD was slightly depressed. Increasing protein concentration in the supplements was associated with increases in both straw intake and DMD.

(Key Words: Frequency, Protein, Supplementation, Digestion Characteristics.)

Introduction

Less frequent winter supplementation on range may serve to reduce labor costs and thereby enhance profit. Little research has compared digestion characteristics of supplements with different protein concentrations fed at different frequencies. Our objective was to determine the digestion characteristics of animals consuming wheat straw when supplemented with soybean meal/sorghum grain

mixtures containing different crude protein concentrations at two different frequencies.

Experimental Procedures

Eight ruminally cannulated steers were blocked by weight and assigned to two, concurrent, 4 × 4 Latin squares. The trial consisted of four periods in which the supplements were randomly rotated through each Latin square. Each period consisted of a 13-day adaptation, a 7-day forage intake period, a 7-day period for determining digestibility via total fecal collection, and a 2-day fermentation profile. Steers in one square were supplemented daily (4.3 lb DM basis), and steers in the other square, three times weekly (10.2 lb DM on Monday, Wednesday, and Friday). Animals in both Latin squares received the same amount of supplement per week (30.5 lb). Supplements contained 12%, 20%, 30%, or 39% crude protein (CP) and consisted of combinations of rolled sorghum grain and soybean meal. Trace mineral blocks were offered free choice. Wheat straw (3.1% CP, 82.0% NDF) was offered at 150% of the average daily intake for the previous week. Fermentation profiles were obtained both on days when all steers were supplemented and when only the 7X group was supplemented.

¹The authors would like to thank Gary Ritter, Wayne Adolph, Tye Engel, Jason Lewis, and the student workers at the Range Research Unit for their invaluable assistance in conducting this trial.

²Department of Statistics.

Results and Discussion

With the exception of fiber digestion, response to altering frequency of protein supplementation did not depend on protein concentration in the supplements. Supplementing 3X lowered ($P < .01$) wheat straw and total intake compared with 7X supplementation (Table 1). Wheat straw and total intake increased as the supplement CP concentration increased and reached a maximum at 30%, but tended to decline thereafter (quadratic, $P = .07$). These observations agree with previously reported effects of protein supplementation on the consumption of bluestem-range forage. The dry matter digestibility of the total diet (straw and supplement) increased ($P \leq .01$) with increasing CP in the supplement and with less frequent supplementation. Digestible dry matter intake increased (cubic, $P = .08$) with increased supplement CP concentration, reached a maximum at 30% CP concentration, and then tended to decrease.

The effect of different protein concentrations in supplements on fiber (NDF) digestibility depended on the frequency of supplementation ($P = .05$). In the 7X group, NDF digestibility improved when supplement CP increased to 20% but was similar (quadratic, $P = .01$) with further increases in CP concentration. In contrast, no protein effect ($P > .10$) was evident in the 3X group. Ruminal pH values for the 3X group on days when they were not supplemented remained fairly constant and in a range that was optimal for fiber digestion (Figure 1). However, on days when both groups were supplemented, pH values were significantly lower in the 3X group than in the 7X group from 8 to 12 hours after feeding.

In conclusion, these data suggest that maximal stimulation of intake of low-quality forage use will occur when high protein supplements are fed on a daily basis. Although straw intake was depressed with less frequent supplementation, increased digestibility may have moderated potential impacts on performance.

Table 1. Influence of Frequency of Supplementation and Protein Concentration in Supplements on Digestion Characteristics of Beef Steers Offered Straw.^a

Item	Protein concentration				SE	L	P _≤		Frequency ^b		SE	P _≤
	12%	20%	30%	39%			Q	C	7X	3X		
Straw DMI ^c , lb/d	12.11	13.07	13.90	13.25	.42	.04	.07	.48	14.57	11.60	.46	.01
Total DMI, lb/d	16.47	17.43	18.26	17.61	.42	.04	.07	.48	18.93	15.96	.46	.01
Straw DMI%BW ^d	1.20	1.30	1.38	1.32	.04	.03	.07	.49	1.42	1.18	.04	.01
Total DMI% BW	1.64	1.73	1.82	1.76	.04	.03	.07	.49	1.85	1.63	.04	.01
Total DDMI ^e , lb/d	7.94	8.71	9.81	9.44	.21	.01	.02	.08	9.37	8.59	.20	.03
Total DDMI%BW	.79	.87	.98	.94	.02	.01	.02	.08	.91	.87	.02	.27
DMD ^f %	48.68	50.29	54.14	54.46	.80	.01	.43	.13	49.58	54.20	.73	.01
NDF ^g Digestibility % ^h (dry matter basis)												
7X	46.38	51.57	52.17	50.47	.42	.01	.01	.28				
3X	53.20	51.92	53.41	54.82	1.38	.34	.37	.66				

^aSE = standard error. L = linear. Q = quadratic. C = cubic. ^b7X = received supplement daily. 3X = received supplement three times weekly. ^cDMI = dry matter intake. ^dBW = body weight. ^eDDMI = digestible dry matter intake. ^fDMD % = dry matter digestibility percent. ^gNDF = neutral detergent fiber. ^hSignificant frequency × protein interaction ($P = .05$).

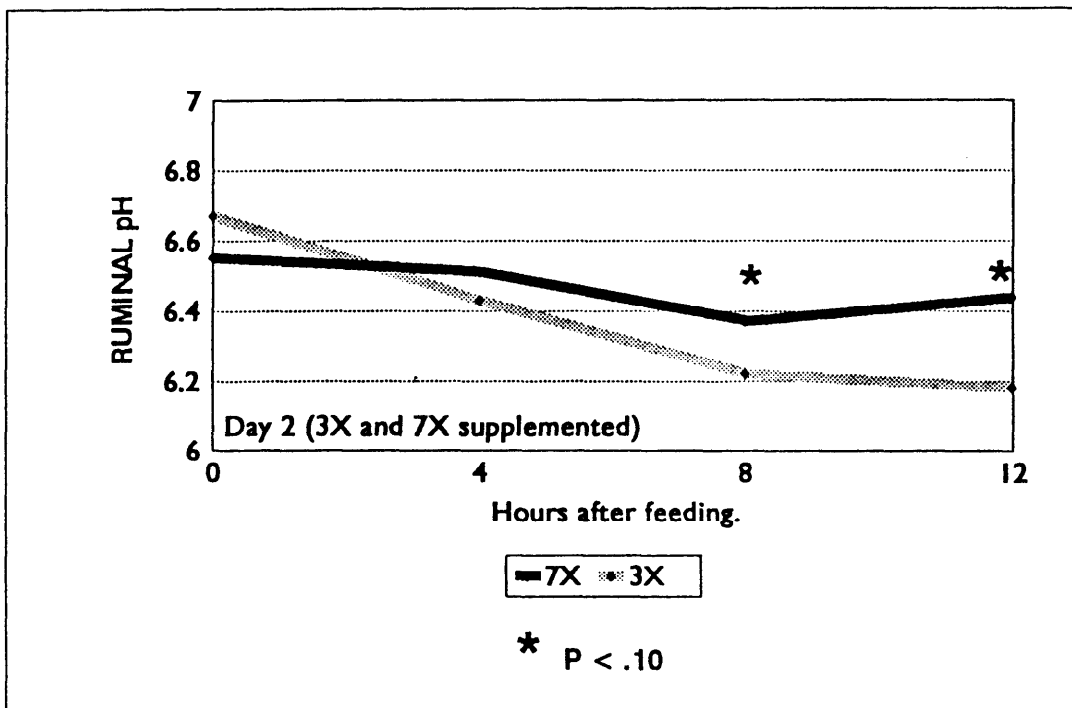
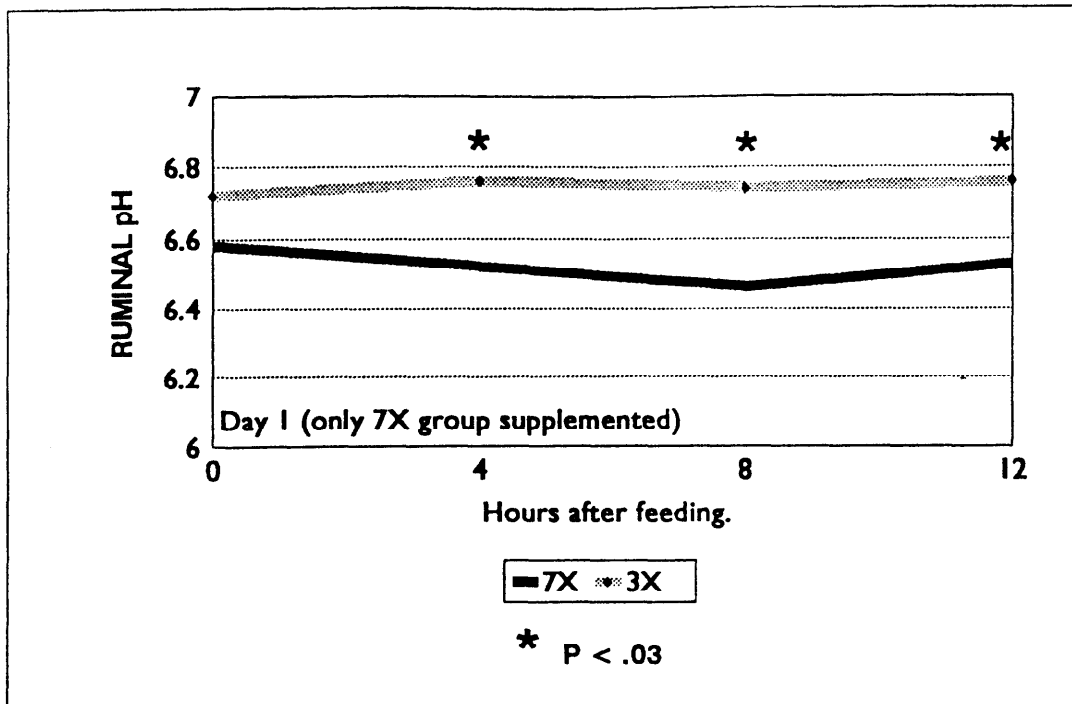

Figure 1. Ruminal pH in Steers Supplemented Daily (7X) or Three Times Weekly (3X)

EFFECT OF LEVEL OF SUPPLEMENTAL ALFALFA AND ITS METHOD OF PROCESSING ON INTAKE AND UTILIZATION OF WHEAT STRAW¹

***B. A. Lintzenich, R. C. Cochran, E. S. Vanzant,
J. L. Beaty, G. St. Jean, R. T. Brandt, Jr.,
and T. G. Nagaraja***

Summary

Sixteen ruminally fistulated steers were used to study the effects of supplemental alfalfa level (.25 or 1.0% body weight [BW]) and method of processing (hay or pellets) on wheat straw utilization. Response to increased level of supplemental alfalfa did not dependent on method of processing (longstem vs pelleted) for the quality of alfalfa (22.7% CP) used in this trial. Increasing the level of alfalfa from .25 to 1.0% of BW reduced ($P \leq .02$) straw intake and diet digestibility, but increased ($P < .002$) digestible dry matter intake by steers. With high quality hay, ground and pelleted alfalfa elicits the same type of response as longstem alfalfa.

(Key Words: Supplements, Alfalfa, Processing, Cattle, Wheat Straw.)

Introduction

Previous research has shown that protein supplements enhance intake and utilization of low-quality forages. In addition, when fed at low levels, alfalfa has been shown to elicit the same type of response as concentrate supplements (when fed to provide the same amount of protein). Our previous work showed a linear decrease in intake of a low-quality forage when increasing levels of supplemental longstem alfalfa hay were fed. Therefore, our objective was to determine whether the method of processing supplemental alfalfa would alter the response to increasing level of supplementation when steers were fed

a basal diet of a low-quality roughage (wheat straw).

Experimental Procedures

Sixteen ruminally fistulated steers (average BW = 965 lbs) were used in a 2×2 factorially arranged experiment to determine the effects of alfalfa level and method of processing on wheat straw intake and utilization. Main effects were level of supplementation (.25 vs 1.0% of BW) and method of processing (no processing of hay vs grinding and pelleting. Hay from a single cutting of alfalfa was used, and half the hay bales were randomly selected for grinding (3/8 inch screen) and pelleting. Contents of CP and NDF were 22.7 and 30.3% vs 19.3 and 34.3% for hay and pellets, respectively. Wheat straw (5.4% CP, 77% NDF) was fed ad libitum by offering 130% of the previous 5 days' average intake. Steers were fed once daily and were adapted to diets for 14 d then fitted with fecal bags for 7 days of total fecal collection to determine digestibility. After the fecal collection, each steer's rumen was manually emptied before (0 h) and 4 hours after feeding to determine ruminal dry matter (DM) and liquid fill.

Results and Discussion

The lower CP and higher NDF in the pellets likely reflect leaf loss during grinding and pelleting. Processing had little impact ($P > .10$) on dry matter intake, dry matter (DM) digestibility, and fill (Table 1). However, increasing the level of alfalfa supple-

¹The authors would like to thank Gary Ritter, Wayne Adolph, and the student workers at the Range/Cow-calf unit for their invaluable assistance in conducting this trial.

mentation reduced wheat straw intake and fiber (NDF) digestion ($P \leq .02$). Although alfalfa DM is more readily digestible than wheat straw, the fiber fraction in alfalfa is poorly digested. Thus, the reduced NDF digestion is likely due to the increased contribution of alfalfa to the diet and potential increases in rate of digesta passage resulting from increased total intake of dry matter. Because of the greater DM digestibility of alfalfa and the greater total

amount of DM consumed for the high supplementation treatment, digestible dry matter intake was increased ($P < .01$) by increasing the level of supplemental alfalfa.

In conclusion, response to an increased level of supplemental alfalfa did not depend on the method of processing for the high quality of alfalfa we used. However, the response to supplement level might have been different, if alfalfa quality had been lower.

Table 1. Effect of Level of Supplemental Alfalfa and Processing on Intake, Digestion, and Rumen Fill^a

Item	Level		Processing		SE	Probability	
	.25%	1.0%	Hay	Pellets		L	P
Total DMI, % BW	1.78	2.21	1.94	2.04	.07	.01	.33
Straw DMI, % BW	1.56	1.24	1.35	1.45	.05	.01	.27
Supplement, DMI, % BW	.23	.91	.57	.57	.01	.01	.67
DM digestion, %	58.1	59.8	59.4	58.4	.9	.21	.48
NDFD, %	64.0	58.4	61.5	61.0	1.3	.02	.78
DDMI, lb/d	10.05	12.53	11.03	11.56	.42	.01	.39
0 h DM fill, lb	37.34	32.71	37.57	32.49	3.54	.36	.34
4 h DM fill, lb	48.40	54.59	48.18	54.59	2.87	.16	.13
Liquid fill, L	79.4	72.4	76.2	75.5	2.9	.12	.83

^aL = level of supplementation; P = method of processing; SE = standard error; DMI = dry matter intake; % BW = percent of body weight; NDFD = neutral detergent fiber digestion; DDMI = digestible dry matter intake.

INFLUENCE OF METHOD OF PROCESSING SUPPLEMENTAL ALFALFA ON INTAKE AND UTILIZATION OF DORMANT, BLUESTEM-RANGE FORAGE BY BEEF STEERS¹

*B. A. Lintzenich, R. C. Cochran, E. S. Vanzant,
J. L. Beaty, R. T. Brandt, Jr., T. G. Nagaraja,
and G. St. Jean*

Summary

A digestion trial was conducted to determine the effect of method of processing supplemental alfalfa on the intake and utilization of dormant, bluestem-range forage. Supplement treatments were 1) control: no supplement; 2) ground and pelleted, suncured alfalfa; 3) ground and pelleted dehydrated alfalfa; and 4) longstem alfalfa hay. Bluestem forage intake (% BW), diet digestibility, and ruminal dry matter fill 4 hours after feeding were increased ($P < .10$) when supplemental alfalfa was fed, compared with no supplementation. Little difference was evident among different forms of supplemental alfalfa for most of the forage utilization characteristics measured. However, a weak trend ($P = .18$) was observed for increased intake of bluestem forage by the steers supplemented with dehydrated alfalfa pellets compared with suncured alfalfa pellets.

(Key Words: Supplements, Intake, Crude Protein Flow, Dormant Range, Alfalfa.)

Introduction

Previous research has demonstrated that protein supplements enhance intake and utilization of poor-quality forages. It has also been shown that alfalfa can be successfully used as a protein supplement. A 1990 study showed some improvement in forage intake and performance in beef cattle fed dehydrated alfalfa pellets as a supplement, compared with

longstem alfalfa hay. However, it was unclear whether the improved response was from reduced particle size, alteration of protein degradability, or a combination of both. Our objective was to measure intake and forage utilization by beef steers fed bluestem-range forage supplemented with different forms of alfalfa.

Experimental Procedures

Four ruminally and duodenally fistulated crossbred steers (average BW = 845 lb) were rotated (Latin square experiment) through the following supplementation treatments: 1) control, no supplement; 2) ground and pelleted, suncured, alfalfa supplement; 3) ground and pelleted, dehydrated, alfalfa supplement; and 4) longstem, alfalfa hay supplement. The alfalfa was from a single cutting (July 14, 1990), and harvested material from alternate windrows was either dehydrated and pelleted or conserved in small square bales. Half of the bales subsequently were ground and pelleted to form the suncured pellets. All alfalfa supplements contained an average of 20% crude protein (CP). The supplements were fed at .5% of BW, and the dormant bluestem-range forage (2.6% CP, 75% NDF) was fed ad libitum at 130% of the previous 5 days' average intake. The steers were fed twice daily, 12 hours apart. To determine intake and digestibility, the steers were fitted with fecal bags for a 7-day intake and total fecal collection period following a 14-d adaptation. Ruminal dry matter and liquid fill were

¹The authors would like to thank Gary Ritter, Wayne Adolph, Tye Engel, Jason Lewis, and the student workers from the Range/Cow-calf Unit for their invaluable assistance in conducting this trial.

determined by manually emptying each steer's rumen just before and 4 hr after the a.m. feeding.

Results and Discussion

Bluestem forage intake (% BW), diet dry matter (DM) digestibility, ruminal DM fill 4 hours after feeding, and ruminal liquid fill increased ($P < .10$) when supplemental alfalfa was fed as compared with no supplementation (Table 1). Because of the enhanced intake elicited by alfalfa supplementation and the concomitant improvement in digestibility, digestible DM intake also increased ($P < .10$) when supplemental alfalfa was fed as compared with no supplementation. Little difference was evident among the different forms of alfalfa with respect to the forage

utilization characteristics measured, except a trend ($P = .18$) for increased total intake and forage intake by steers supplemented with dehydrated alfalfa pellets compared with suncured alfalfa pellets. This trend appears to be corroborated by the differences observed in DM fill measured 4 hours after feeding. The limited differences among the different forms of supplemental alfalfa may be due to the fact that the quality of supplements was very similar (hay was kept in a covered shed until processing) and relatively high. Under field conditions, suncured pellets are often made from lower quality hay that has been subjected to some degree of weathering. Under such conditions, dehydrated alfalfa pellets would be expected to be higher in quality and, therefore, might elicit improved performance.

Table 1. Influence of the Form of Supplemental Alfalfa on Intake, Digestibility, Protein Flow, and Rumen Fill^a

Item	Treatment				SE
	Control	Dehy	Sun	Long	
<u>DM Intake, % BW</u>					
Total	.83 ^b	2.09 ^c	1.86 ^c	1.90 ^c	.11
Forage	.83 ^b	1.59 ^c	1.36 ^c	1.42 ^c	.11
Supplement	.00	.50	.48	.50	
<u>Total Tract Digestibility, %</u>					
DM	34.41 ^b	49.68 ^c	47.28 ^c	49.39 ^c	2.64
NDF	44.97	48.53	49.85	52.82	3.65
<u>Digestible DM Intake, lb/d</u>					
	2.13 ^b	8.48 ^c	7.22 ^c	7.69 ^c	.58
<u>Rumen Fill</u>					
DM, lb					
0 hour	16.25	18.92	17.01	18.56	1.07
4 hour	17.17 ^b	22.57 ^c	19.73 ^{cd}	19.31 ^{bd}	.83
Liquid, liter ^e	46.16 ^b	70.29 ^c	54.83 ^c	57.04 ^c	2.37

^aSE = Standard error; % BW = percent of body weight; DM = dry matter; NDF = neutral detergent fiber.

^{b,c,d} Row means with different superscripts differ ($P < .10$).

^eNo treatment \times time interaction ($P > .10$). Values are an average of 0 and 4 h evaluations.

GROWTH AND REPRODUCTIVE CHARACTERISTICS IN HEIFERS FED ENDOPHYTE-INFECTED TALL FESCUE AND OXYTETRACYCLINE¹

C. W. Peters, F. K. Brazle², and L. R. Corah

Summary

Heifers developed on high-endophyte, tall fescue gained half as much weight (56 vs 117 lb; $P < .01$) and had a lower 35-day pregnancy rate (15 vs 58%; $P < .01$) compared to heifers fed low endophyte, tall fescue. Based on progesterone serum concentrations and visual determination of estrus, the proportion of heifers that had attained puberty by the start of the breeding season tended ($P = .11$) to be greater when fed oxytetracycline (55 vs 68%).

(Key Words: Tall Fescue, Reproduction, Puberty, Beef Heifers, Oxytetracycline.)

Introduction

Tall fescue is excellent in terms of yield and persistence; however, growth and reproductive performance by animals grazing tall fescue have generally been inferior to those of animals grazing other cool-season grasses. Tall fescue occupies approximately 35 million acres across the middle and southeastern U.S., including the eastern one-third of Kansas. About 22% of the nation's cows grazes tall fescue, approximately 80% of which is infected with an endophytic fungus, *Acremonium coenophialum*. Endophyte-infected tall fescue reduces feed intake and weight gain by growing cattle. One objective of this study was to determine the effect of endophyte-infected tall fescue on growth, onset of puberty, and reproductive performance by crossbred beef heifers. Because antibiotics

improve performance in grazing and feedlot cattle, our second objective was to determine if feeding the antibiotic, oxytetracycline, during the growing period would prevent the detrimental effects of endophyte.

Experimental Procedures

During a 160-d study (January to June), 136 Angus crossbred heifers were used in a completely randomized design with a 2×2 factorial experiment. Treatment diets consisted of low-endophyte (< 15% infection) or high-endophyte (> 90% infection) tall fescue hay and bromegrass seed (0% infection) or high-endophyte (> 90% infection) tall fescue seed with or without 240 mg/hd/d oxytetracycline. Heifers were offered forage *ad libitum* on a pen basis each day along with 5.9 lb/day of a 16.8% crude protein supplement of milo and soybean meal. Onset of puberty was determined by measuring serum progesterone in blood collected every 10 d during the study, coupled with visual confirmation of estrus. Heifers were weighed every 28 d. The breeding season started on May 15. The two blood samples immediately prior to that date were used to determine puberal status at the start of breeding. During the 35-d breeding period, heifers were inseminated artificially with semen from one sire, approximately 12 h after visual detection of estrus; at least two services were allowed per heifer and no cleanup bulls were used. Rectal temperature was recorded at the time of insemination. Pregnancy was determined by uterine palpation

¹Authors are grateful to C. Binns, B. Fox, R. Hightshoe, R. Perry, and T. Ridder for data collection.

²Extension Livestock Specialist, Southeast Kansas.

per rectum following trial completion.

Results and Discussion

Levels of crude protein and crude fiber in hay and seed fed to heifers are presented in Table 1. Table 2 details average hay and seed intake for the four treatments.

Initial heifer weights among the four treatments were similar at the beginning of the study (Table 3). However, heifers fed the high endophyte diet gained less than half as much ($P < .01$) as heifers fed the low- endophyte diet. Onset of puberty was not affected by endophyte infection, but feeding oxytetracycline tended ($P = .11$) to increase

the number of heifers puberal at the start of the breeding period. Consumption of high-endophyte diets decreased ($P = .02$) the percentage of heifers detected in estrus during the breeding season and decreased ($P < .01$) first service and overall pregnancy rates, possibly because of increased ($P = .04$) rectal temperature and lower ($P = .08$) serum progesterone at first service.

As expected, heifers consuming high-endophyte, tall fescue hay gained less weight and were less fertile than heifers consuming low-endophyte, tall fescue. The antibiotic oxytetracycline may help alleviate some of the negative effects of endophyte-infected tall fescue, especially in terms of puberty attainment prior to the breeding season.

Table 1. Crude Protein and Crude Fiber Content of Low- and High-Endophyte Fescue Fed to Developing Heifers

Item	Diet components ^a			
	LE Hay	LE Seed	HE Hay	HE Seed
Crude protein, %	8.0	12.3	8.8	13.1
Crude fiber, %	34.8	25.5	33.8	22.3

^aLE Hay= low-endophyte, tall fescue hay; LE Seed= grass seed; HE Hay= high-endophyte, tall fescue hay; HE Seed= high-endophyte, tall fescue seed.

Table 2. Average Hay, Seed, Supplement, and Antibiotic Intake by Heifers Fed High- or Low-Endophyte, Tall Fescue

Item	Treatments ^a			
	LE-OTC	LE+ OTC	HE-OTC	HE+ OTC
Intake, lb/d				
Hay	9.8	10.0	8.9	8.9
Seed	1.1	1.1	1.3	1.3
Supplement	5.9	5.9	5.9	5.9
Antibiotic intake, mg/d				
Oxytetracycline	0	240	0	240

^aLE= low-endophyte; HE= high-endophyte; OTC= oxytetracycline.

Table 3. Effect of Endophyte-Infected Tall Fescue and Oxytetracycline on Heifer Growth, Puberty, and Reproductive Performance

Item	Treatments ^a				SE	Effect ^b
	LE-OTC	LE+ OTC	HE-OTC	HE+ OTC		
No. of heifers	34	34	34	34		
Initial wt, lb	558	562	571	556	11	-
Wt gain, lb	115	119	53	59	7	E
Puberty, % ^c	56	71	53	65		OTC (P= .11)
P ₄ , ng/ml ^d	1.9	1.6	1.5	1.4	.2	E
Estrus, % ^e	85	88	65	77		E, E× OTC
RT, ^f	103.1 ^g	104.2 ^{hi}	104.9 ⁱ	103.6 ^{gh}	.4	E, E× OTC
Pregnant (based on number serviced)						
1 st service, %	45	27	5	12		E, E× OTC
Overall, %	52	63	18	12		E, E× OTC

^aLE= low-endophyte; HE= high-endophyte; OTC= oxytetracycline.

^bDenotes a significant (P< .10) effect of endophyte level (E), oxytetracycline (OTC) or their interaction (E× OTC).

^cPercentage of heifers that attained puberty prior to the breeding period.

^dAverage serum progesterone prior to the breeding period.

^ePercentage of heifers that were detected in estrus during the breeding period.

^fRectal temperature at time of insemination.

^{ghi}Means within a row without a common superscript letter differ (P< .05).

ENDOPHYTE-INFECTED, TALL FESCUE HAY UTILIZATION BY EXERCISED, YEARLING HORSES

*J. S. Pendergraft, M. J. Arns, R. H. Raub,
K. K. Bolsen, and F. K. Brazle¹*

Summary

Fescue toxicity causes substantial production losses in sheep, cattle, and horses. These losses are attributed to an endophyte, *Acremonium coenophialum*. However, our results indicate that Quarter horse yearlings can be fed endophyte-infected tall fescue hay for at least 106 days with no detrimental effects on either growth or exercise performance. However, these findings have not been substantiated in other classes of horses or in horses consuming endophyte-infected fescue for longer durations.

(Key Words: Tall Fescue, Endophyte, Yearling Horses, Exercise.)

Introduction

Livestock consuming tall fescue frequently show poor growth performance. Several studies also indicate poor reproduction performance in broodmares consuming tall fescue infected with an endophyte fungus (*Acremonium coenophialum*). However, there are few data on the effects of feeding endophyte-infected tall fescue hay on performance of young growing horses. Our objectives were to measure growth and exercise performance in yearling horses fed endophyte-infected hay.

Experimental Procedures

Twelve Quarter horse yearlings were blocked initially by age (12 to 16 months) and sex (six geldings and six fillies) and randomly assigned to one of three hay treatments:

native prairie (P), endophyte-free tall fescue (EF), or endophyte-infected tall fescue (EI). The ergovaline concentration in the EI hay was 190 ppb, with none detected in either the P or EF hays. Yearlings were fed their respective hays and a corn and oat-based concentrate (Table 1) in a 55:45 ratio to meet NRC (1989) recommended nutrient requirements for growth. Rations were fed twice daily for 106 days (July 1 to October 14, 1991) in dry lots that averaged 80 by 100 ft. Initially and at 14 day intervals, the horses were weighed, measured for wither and croup heights, and evaluated for body condition score.

The four horses in each group were

Table 1. Composition of the Concentrate and Supplement Portion of the Concentrate

Ingredients	%, as fed basis
Corn, cracked	40
Oats, rolled	37
Supplement pellet ¹	20
Cane molasses	3

¹Composition of the supplement (% as fed basis): soybean meal, 55.5; dehydrated alfalfa, 33.4; dicalcium phosphate, 4.6; limestone, 2.4; trace mineral salt, 2.7; vitamin premix, 1.3; and copper sulfate, .03.

¹Southeast Area Extension Office, Chanute.

exercised biweekly at noon by a mechanical walker. Exercise duration started at 10 min and increased by 5 min every 4 weeks until the final exercise period. Respiration, heart rate, and body temperature were recorded at the start of exercise and at 5, 30, and 60 min post-exercise. Daily rectal body temperature was taken between 3:30 and 4:30 p.m.

Blood was collected from the jugular vein at the start of the study and at 28-day intervals. Serum was harvested and stored at -20°C until assayed for calcium, phosphorus, prolactin, thyroxine (T_4), and triiodothyronine (T_3). Apparent nutrient digestibilities were measured using chromic oxide as a marker. Fecal grab samples were taken for 3 days at 3-hour intervals after the 7:00 a.m. feeding to represent a 12-hour collection period.

Data were analyzed by analysis of variance as a split plot over time, and significant differences were separated using Fisher's LSD test.

Results and Discussion

The chemical compositions of the three hays were similar. Crude protein ranged from 5.7 to 7.2% and acid detergent fiber, from 40.0 to 42.2% (dry basis). Nutrient digestibilities were not affected ($P > .05$) by the endophyte in fescue hay. In fact, crude protein digestibility was highest ($P < .05$) for the infected-hay ration. Average daily gain, changes in wither and croup heights, and body condition scores were all similar ($P > .05$) for the three hay sources (Table 2). In addition, serum calcium, phosphorus, T_3 , T_4 , and prolactin concentrations were similar ($P > .05$) and all within normal ranges among hay treatments. Exercise performances, as measured by respiration rate, heart rate, and rectal temperature, were also similar for all three hay rations.

These data suggest that, for at least 106 days, young growing horses can be fed endophyte-infected tall fescue hays without degrading growth or performance. Further studies should examine the apparent differences between the way horses and cattle react to endophyte, and how horses react long-term.

Table 2. Growth Performance of Yearling Horses Fed the Three Hay Treatments

Item	Hay			SE ^a
	Prairie	Endophyte-free	Endophyte-infected	
Initial wt, lb	745	741	729	10.2
Final wt, lb	902	924	908	10.2
Average daily gain, lb	1.52	1.72	1.61	.6
Final body condition score ^b	6.25	6.25	6.13	.09
Growth in croup height, in.	2.19	1.75	2.19	.22
Growth in wither height, in.	1.50	1.88	2.25	.24

^aStandard error of the mean.

^b1 = extremely thin; 9 = extremely fat.

PASTURE AND SUBSEQUENT FEEDLOT PERFORMANCE BY BEEF CATTLE GRAZING *ACREMONIUM COENOPHIALUM*-INFECTED TALL FESCUE AND OFFERED DIFFERENT LEVELS OF GROUND GRAIN SORGHUM

A. S. Freeman¹ and K. P. Coffey²

Summary

One hundred twenty-six crossbred steers and sixty-three crossbred heifers (704 lb BW) were used to evaluate the effects of energy supplementation on animal performance during grazing of endophyte-infected tall fescue and on subsequent feedlot performance. Grazing ADG increased linearly ($P < .05$) from .70 lb/d for control (no supplementation) to .93 and 1.12 lb/d for cattle receiving .25% and .5% of BW as ground sorghum grain (SG), respectively. Initial feedlot weight was increased linearly ($P < .02$) by pasture SG levels. Feedlot daily gain, dry matter intake, and feed conversion; carcass characteristics; and liver abscess scores were not affected ($P > .10$) by SG that had been fed on pasture.

(Key Words: Sorghum Grain, Steers, Heifers, Grazing Performance, Feedlot Performance, Carcass Merit, Fescue, Endophyte.)

Introduction

Cattle grazing endophyte-infected fescue frequently show signs of fescue toxicosis or 'summer slump' and are often discounted when purchased by feedlots. Various management practices have been applied to reduce these toxic effects. Sorghum grain has been used to improve rate of gain of grazing cattle, but cattle offered supplemental grain during grazing often exhibit reduced performance and efficiency in the feedlot. Supplemental grain reduces forage intake, so offering grain

supplements to cattle grazing endophyte-infected fescue should dilute its toxic effects, which, in turn, should have a dramatic effect on animal performance. However, effects on subsequent feedlot performance remain unknown. This study was conducted to evaluate the effects of supplementation with different levels of ground sorghum grain on pasture and subsequent feedlot performance by beef cattle grazing endophyte-infected tall fescue pastures.

Experimental Procedures

Grazing Phase. Ninety crossbred yearling steers each year in 1990 and 1991 and 90 crossbred yearling heifers in 1992 were used in a 3-year experiment to determine the effects of different levels of supplemental ground grain sorghum on performance of stocker cattle grazing endophyte-infected fescue. During each grazing season, cattle were vaccinated against IBR, BVD, PI3, five strains of leptospirosis, seven clostridial strains, pinkeye, and BRSV; were dewormed; received an insecticide ear tag; and then were commingled for 7 days on a mixed pasture of endophyte-free fescue, bromegrass, and native grass. Cattle were randomly allotted by weight into nine groups of seven head each, then transported to one of nine 5-acre *A. coenophialum*-infected tall fescue pastures (70% of the plants infected), where they grazed for an average of 62 days. Pastures were randomly allotted such that steers grazing

¹Southwest Research-Extension Center, Garden City, Kansas.

²Southeast Kansas Branch Experiment Station, Parsons, Kansas.

each of the nine pastures were assigned to a control (no supplement) or were offered ground sorghum grain at levels of .25% and .5% of body weight daily, with three pastures per grain level. The remaining 27 animals were evenly distributed across experimental pastures to control excess forage production. Water and mineral blocks containing Rumensin® (Monensin, 800 g/ton) were provided free-choice. Grain levels were adjusted according to interim weights measured at 21-day intervals.

Beginning and ending weights were measured on the mornings of two consecutive days without prior removal from pasture and water. Following ending weights, cattle were moved to endophyte-free pastures for a 5- to 7-day period to equalize gut fill. Cattle were then transported overnight to the Southwest Research-Extension Center, Garden City, KS for the feedlot phase of the trial.

Feedlot Phase. Cattle received into the feedlot were individually weighed and processed within 24 hours of arrival. Processing included implanting with Compudose® 200; de-licing and de-grubbing with Tiguvon® (Fenthion); and vaccinating against IBR, BVD, PI3, five strains of leptospirosis, seven clostridial strains, and *Haemophilus somnus*. Cattle were then divided into groups of 10 head and placed in feedlot pens overnight, with fresh bromegrass hay and water. A second initial weight was taken the following day. Animals were then sorted into pens with seven head each to maintain grazing-phase treatment structure.

All cattle received a starter ration on arrival and were stepped-up to a finishing diet (Table 1) over a 13-day period. Fourteen days after arrival, animals were revaccinated against IBR, BVD, PI3, and five strains of leptospirosis and were dewormed with Valbazen® (Albendazole). Deccox® (Decoquinatate) was fed (180 mg/head daily) for an average of 20 days, then removed from the ration. Monensin and Tylan® (Tylosin) were then fed for 7 days at 150 and 90 mg/head daily, respectively. Monensin was then increased to 300 mg/head daily for the remaining feedlot period. During the 1992

study, the heifers received .40 mg/head/d of MGA® (melengestrol acetate) in the finishing ration.

Table 1. Percent Composition and Nutrient Analysis of Finishing Diets on a Dry Matter Basis

Item	Year		
	1990	1991	1992
Steam-flaked corn	76.3	75.0	0
Steam-flaked milo	0	0	75.3
Alfalfa hay	5.8	5.8	5.4
Corn silage	7.8	7.9	7.4
Molasses	2.4	1.3	1.3
Tallow	0	1.9	4.8
Supplement ^a	7.8	8.5	5.8
Dry matter	74.7	75.9	76.7
Crude protein	11.9	11.9	13.3
ADF ^b	6.0	6.9	11.1
NEm, Mcal/cwt	99	102	95
NEp, Mcal/cwt	68	69	62
TDN ^c	85.5	87.1	82.0
Ca	.97	.99	.91
P	.37	.36	.34
K	.90	.91	.96

^aPelleted supplement: Wheat millfeed, 29%; calcium carbonate 23%; dehy alfalfa, 15%; urea, 8.6%; potassium chloride, 7.9%; meat and bone meal, 5.1%; salt, 4.0%; ammonium sulfate, 4.0%; dicalcium phosphate, 2.3%; and trace mineral package, .75%.

^bAcid detergent fiber.

^cTotal digestible nutrients.

Dry matter intake was recorded daily. Interim weights and 2-day final weights were measured before the once-a-day morning feeding to calculate rate of gain and feed conversion. Cattle were slaughtered at a local packing plant, and liver abscess scores were recorded. Carcass characteristics were measured after a 24-h chill.

Results and Discussion

Grazing Phase. Statistical analysis indicated no year by SG level interactions.

Pasture gain increased linearly ($P < .05$) with increasing SG level (Table 2). Each pound of supplemental SG produced .12 lb additional gain. Grain consumptions averaged across years were 0, 112, and 228 lb for the 0, .25%, and .5% GS levels, respectively.

Feedlot Phase. No year by SG level interactions were noted for any feedlot performance data. All animals experienced an average transit shrink of 5.9% (Table 2). Across treatments, fill losses were regained in approximately 13 days. A linear response was evident for pasture total gain. Initial feedlot weight also increased linearly ($P < .02$), with increasing SG. Total feedlot weight gain (avg 466 lb) and ADG (avg 3.58 lb) was not affected ($P > .10$) by SG level for the 130-day finishing phase. Dry matter intake (avg 20.8 lb) and feed conversion (avg 17.3 lb gained/100 lb dry matter consumed) were also not affected ($P > .10$) by SG level. Total weight gains (grazing plus feedlot)

were 462, 477, and 481 lb for 0, .25%, and .5% GS levels, respectively.

Hot carcass weight (avg 731 lb), dressing percent (avg 62.1%), rib-eye-area (avg 13.2 in.²), KPH (avg 2.47%), percent choice (avg 42%), quality grade (avg Choice minus), and liver abscess score (avg 1.56) were not affected ($P > .10$) by SG levels (Table 2). Adjusted back fat thickness and yield grade responded to SG levels differently, depending on grazing year (Interaction $P < .07$).

In conclusion, supplemental ground sorghum grain up to .5% of body weight improved pasture performance of stocker cattle grazing endophyte-infected tall fescue pastures without negatively affecting subsequent feedlot performance or carcass characteristics.

Table 2. Effect of Grain Sorghum Level during Pasture Phase on Grazing and Subsequent Feedlot Performance and Carcass Merit of Cattle Grazing *A. coenophialum*-infected Tall Fescue Pastures

Item	Grain level, % of body weight		
	Control	.25	.5
<u>Pasture phase</u>			
Pastures per year	3	3	3
No. of cattle	63	61	63
Initial wt., lb	705	701	704
Final wt., lb ^a	748	759	772
Pasture gain, lb ^a	43	57	68
Gain, lb/head/d ^a	.70	.93	1.12
Grain consumption, lb/head/d ^b	0	1.8	3.7
Total grain consumed lb	0	112	228
<u>Feedlot phase - performance</u>			
Pens per year	3	3	3
No. of cattle	63	61	63
Initial wt., lb ^c	700	710	721
Transit shrink %	6.0	5.9	5.7
Final wt., lb	1,167	1,178	1,185
Gain, lb	467	468	464
Daily gain, lb	3.59	3.60	3.57
Dry matter intake, lb	20.8	20.7	21.0
Gain to feed ^d	17.3	17.4	17.2
<u>Carcass merit</u>			
Hot carcass wt., lb	723	730	739
Dressing percent, %	62.0	61.9	62.4
Ribeye area, in. ²	13.4	13.0	13.3
Backfat, in. ^e	.40	.44	.44
Kidney-pelvic-heart fat, %	2.44	2.44	2.52
USDA yield, calculated ^e	2.44	2.72	2.65
USDA quality grade	5.12	5.20	5.16
Percent choice, %	38	42	46
Liver abscess score ^f	1.4	1.4	1.8

^aLinear increase (P < .05).

^bLinear increase (P < .01).

^cLinear response (P < .02).

^dGain to feed ratio based on lb gained per 100 lb DMI.

^eYear by SG level interaction (P < .07).

^fUSDA Quality grade: 5.00 to 5.29 = small degree of marbling, Choice -; 5.30 to 5.59 = modest, Choice 0; 5.60 to 5.99 = moderate, Choice +.

^gLiver abscess score: 1 = not condemned, 2, 3, and 4 = condemned due to increasing severity of abscess damage.

EFFECT ON SUMMER STOCKER GAINS WHEN NATIVE GRASS PASTURES WERE EITHER GRAZED SHORT DURING THE DORMANT SEASON OR BURNED IN APRIL¹

F. K. Brazle²

Summary

Four hundred and ten mixed-breed heifers were intensively early grazed for 81 days on native tall grass pastures where dormant growth had been removed by either winter grazing or April burning. Heifers grazing the burned pastures gained .19 lb/day more (1.99 vs 1.80 lb; $P < .05$) than those grazing pastures that had the dormant grass removed by heavy grazing during February and March.

(Key Words: Burning, Stocker Cattle, Native Grass.)

Introduction

The benefit of late spring burning of native grass to improve daily gain of stocker cattle is well documented. Recently, some producers have questioned whether or not the same benefits could be achieved by closely grazing the dormant grass during the preceding winter. Therefore, the objective of this study was to determine the effect on stocker cattle gains of heavily grazing native tall grass during late winter compared to late spring burning.

Experimental Procedures

Four hundred and ten mixed-breed heifers were allotted randomly to native grass pastures that had been either burned or winter grazed, with two pasture replications per treatment. The winter-grazed pastures were grazed heavily in February and March, so that most

of the dormant native grass was removed (80% of the pasture grass was under 4 in. tall). The burned pastures were burned in April, resulting in 80 to 90% of the dormant grass being removed. The heifers were weighed individually in April before going to grass, were stocked at 2 acres per head, and were grazed for 81 days. All heifers were fed an Aureomycin®-containing mineral mixture, shown in Table 1. In July, the heifers were gathered early in the morning from each pasture, commingled and driven to pens, then weighed individually.

Results and Discussion

The heifers that grazed the burned pastures gained faster (1.99 vs 1.80 lb; $P < .05$) than those on pastures grazed short during the winter. Therefore, simply removing the old top growth did not enhance stocker gains as much as burning in April. The gain difference found in this study was not as great as previously reported by other researchers between burned and unburned pastures. However, those studies were done with yearling steers rather than heifers. Steers normally gain faster than heifers on grass. Therefore, our research confirms that late spring burning is still the most effective grass management practice to enhance stocker gains on intensively early-grazed native range.

¹Sincere appreciation is expressed to Mike Collinge, Hamilton, KS for providing cattle and facilities.

²Extension Livestock Specialist, Southeast Kansas.

Table 1. Antibiotic-containing Mineral Mixture Used in Grazing Trial

Ingredient	%	Lb/ton
Dicalcium phosphate	29.75	595
Aureomycin®, 50 g/lb ^a	3.75	75
Magnesium mica ^b	8.75	175
White salt	25.158	503.175
Dried molasses	15	300
Vitamin A premix, 30,000 IU/g	1.5	30
Zinc oxide	.085	1.7
Iodine, EDDI	.0062	.125
Ground limestone	15	300
Mineral oil	1	20

^aAmerican Cyanamid Co., Princeton, NJ.

^bMicro-Lite Inc., Chanute, KS.

Table 2. Effect of Burning or Winter Grazing of Native Grass on Heifer Summer Gains

Item	Burned pastures	Heavily grazed dormant pastures
No. heifers	229	181
Starting wt., lb	518	518
Grazing period, days	81	81
Daily gain, lb	1.99 ^a	1.80 ^b

^{ab}Means in the same row with unlike superscripts differ ($P < .05$).

RELATIONSHIP BETWEEN EXPECTED PROGENY DIFFERENCES (EPD) AND PERFORMANCE OF ANGUS AND SIMMENTAL BULLS IN CENTRAL BULL TESTS

D. D. Simms

Summary

The performance of bulls ($n = 656$ for Angus and $n = 1343$ for Simmental) at the Beloit and Potwin bulls tests from 1989 to 1992 were compared to their expected progeny differences (EPDs). In general, correlations between on-test ADG and weaning and yearling EPD were low for both breeds. However, the correlations between actual yearling weight and yearling EPD was moderate for Angus. Differences in actual yearling weight were 2.80 and 1.71 pounds (for Angus and Simmental, respectively) for each pound of difference in yearling weight EPD, which is close to the 2.0 pound difference expected. Thus, although the relationship between EPDs and average daily gain on test was not strong, EPDs did a good job of predicting differences in weight at a standardized age.

(Key Words: Bull Tests, Expected Progeny Differences.)

Introduction

The addition of expected progeny differences (EPDs) to the information provided to bull buyers at the Beloit and Potwin bull tests has raised many questions concerning the relationships between actual performance of the bulls and their EPDs. These questions have been particularly prevalent with bulls that have had high EPDs for growth and haven't expressed good growth, or vice versa. These circumstances have created problems for producers in determining what information should be emphasized in selecting bulls. This study was conducted to determine the relationships between actual bull performance

and EPDs in order to assist producers in answering these questions.

Experimental Procedures

The data analyzed in this study were collected from the Beloit and Potwin bull tests conducted from 1988 through 1992 - a total of 13 tests. Only the Angus and Simmental breeds were analyzed, because there were inadequate numbers of bulls in other breeds to provide meaningful comparisons. The two breeds were analyzed separately, because their EPDs have different base years. To avoid differences between tests in performance because of weather, etc., the data were standardized for test differences in performance prior to analysis. The EPDs utilized in the analysis were those published in the final test report and were pedigree or interim estimates provided by the respective breed associations. These estimates took into account the actual birth and weaning weights but not the actual yearling weights of the bulls.

Results and Discussion

The correlations between the EPDs for Angus bulls and their performance on test and other descriptive information are shown in Table 1. Because a large number of bulls was included in this analysis, almost all of the correlation coefficients are statistically significant; however, the relationships between actual performance (ADG on test) and growth EPDs, i.e., weaning and yearling, were much lower than expected. For example, the correlation between average daily gain and yearling EPD was only .13. Conversely, the

relationship between actual yearling weight and yearling EPD was .30. This result is logical when one considers that average daily gain on test is influenced by prior nutritional regimes, disease, age on test, etc., whereas absolute yearling weight tends to eliminate some of this variation between bulls.

The correlations for the Simmental bulls are shown in table 2. The relationships between traits are similar to those in Angus with the exception of yearling weight EPD,

which exhibited a lower correlation with actual yearling weight and weight-per-day-of-age. Again, the general relationships were much lower than expected.

For each pound difference in yearling EPD, the actual adjusted yearling weights changed 2.80 and 1.71 pounds in Angus and Simmental, respectively. These results are reasonably close to the expected value of 2.0 pounds per pound change in the EPD, and provide proof that, on average, EPDs do predict genetic differences.

Table 1. Simple Correlations between Expected Progeny Differences (EPD) and the Performance of 656 Angus Bulls for 1988-92 at the Beloit and Potwin Bull Tests

Item	Expected progeny differences				
	Birth weight	Weaning weight	Yearling weight	Maternal weaning weight	Milk
Final wt.	.27***	.34***	.36***	.22***	.08
ADG	.12**	.10**	.13**	.11**	.04
Birth wt.	.49***	.24***	.19***	.19***	.15***
Weaning wt. ratio	.12**	.31***	.02	.24***	.09*
Weight per day of age	.25***	.31***	.26***	.23***	.11**
Index	.19***	.20***	.20***	.17***	.08*
Yearling wt.	.21***	.36***	.30***	.28***	.15***

*P < .05, **P < .01, ***P < .001.

Table 2. Simple Correlations between Expected Progeny Differences (EPD) and the Performance of 1343 Simmental Bulls for 1988-92 at the Beloit and Potwin Bull Tests

Item	Expected progeny differences				
	Birth weight	Weaning weight	Yearling weight	Maternal weaning weight	Milk
Final wt.	.13***	.32***	.15***	.07**	.30***
ADG	.11***	.20***	.16***	.18***	.06*
Birth wt.	.61***	.17***	.12***	.18***	.08**
Adj. weaning wt.	.11***	.36***	.08***	.39***	.17***
Weight per day of age	.14***	.38***	.17***	.40***	.17***
Index	.13***	.29***	.17***	.29***	.11***
Yearling wt.	.16***	.37***	.17***	.35***	.11***

*P < .05, **P < .01, *** P < .001.

ULTRASOUND-MEASURED RIBEYE AREA EPD FOR BRANGUS CATTLE¹

*R. R. Schalles, M. E. Dikeman, J. B. Glaze, R. Mallen-Spinzi,
K. M. Andries, C. J. Rost, M. Z. Johnson², and W. Olson*

Summary

Ultrasound-measured ribeye area (REA) expected progeny differences (EPD) were calculated for 2974 Brangus cattle. Carcass data were collected from 168 steer progeny sired by eight bulls with ultrasound-measured ribeye area EPDs. A heritability estimate of .40 for ultrasound-measured REA and a 2.82 sq. in. range in genetic differences in ultrasound-measured REAs in this population indicate considerable opportunity to make genetic change in this trait. The regression of progeny average carcass REA on the sire's ultrasound measured ribeye area EPD indicated that for each square inch change in the EPD, the carcass REA of their progeny changed by .69 sq. in. The ultrasound-measured ribeye area EPD of young breeding stock appears to be a reasonably good predictor of their progeny's carcass ribeye area.

Introduction

Surveys have shown that consumers want cattle with a reasonable amount of muscle with good quality and low fat. Tools must be developed that let us select foundation stock to produce cattle to meet those specifications. Collection of carcass data is time consuming and expensive, but ribeye area can be measured directly at moderate cost on young breeding stock using ultrasound equipment. Research has indicated that carcass REA is a good indicator of total muscle. With these facts in mind, a research project was started in

1986 using Brangus cattle to evaluate the feasibility of this technique. One year is the most desirable age at which to obtain the ultrasound-measured REA (1991 KSU Cattlemen's Day report). The genetic parameter estimates for the traits involved were reported in the 1992 KSU Cattlemen's Day report. This project has continued with the calculations of ultrasound-measured REA expected progeny differences (EPD) for Brangus cattle and collection of carcass data from progeny sired by bulls with ribeye area EPDs.

Experimental Procedure

Ultrasound-measured REA and yearling weight were obtained from 2178 yearling Brangus cattle from 1986 to 1992 at Brinks Brangus, Eureka, KS and Auburn University. At measurement, they were between 320 and 410 days of age, and both sexes were measured. A two-trait (yearling REA and yearling weight) animal model was used to calculate EPD for REA. Heritabilities of .40 for REA and .44 for yearling weight, and a genetic correlation of .38 between them (1992 KSU Cattlemen's Day report) were used in the analysis. All animals were evaluated, including 796 parents that did not have their ribeye areas measured, and 2,178 progeny who had ultrasound-measured ribeye areas, for a total of 2,974 animals.

Carcass data were collected from 168 steer progeny produced by eight bulls with

¹Supported by Brinks Brangus Ranch, Eureka, KS and International Brangus Breeders Association.

²Department of Animal Science, Oklahoma State University, Stillwater, OK.

ultrasound-measured ribeye area EPDs in an effort to determine the relationship between the ultrasound-measured trait in young breeding animals and the carcass traits of their progeny. The steers were placed on a finishing ration after weaning at an average age of 284 days and were fed for an average of 129 days, making them 13.6 months old when carcass data were collected at the IBP plant at Emporia, Kansas.

Results and Discussion

The EPDs for ultrasound-measured REA ranged from $-.51$ to $.90$ sq. in. Because the EPD is half of the breeding value, this indicates a genetic difference for REA of 2.82 sq. in. With a heritability of $.4$, considerable change can be made through selection. The genetic trend for the population evaluated is given in Table 1. After ultrasound measurement of REAs became available, some selection was practiced for larger REA, as evidenced by the larger EPDs during the last 2 years.

The average of carcass traits from progeny produced by eight sires and their EPDs are given in Table 2. There was a 1.4 sq. in. difference in REA between the progeny averages of the highest and lowest sire groups. The carcass REAs of progeny were closely related to the EPD of their sire, except for sire 392X, which had one of the larger EPDs but progeny with the smallest REAs. Even so, on the average, for each 1 sq. in. increase in sire's EPD, the progeny carcass REA increased by $.69$ sq. in. The sire group with the largest REA also had the heaviest carcass weight, least back and

kidney-pelvic-heart fat, and lowest yield grade number. The progeny groups with the highest quality grades also had the most backfat. There appears to be little relationship between REA and quality grade. Sire 772X produced progeny with large average REA, one of the higher average quality grades, and a low yield grade.

Table 1. Average Ultrasound-Measured Ribeye Area EPD of Cattle Evaluated by Year of Birth

Birth Year	Ribeye Area EPD ^a
Base Herd	.000
1986	.006
1987	-.003
1988	.007
1989	.040
1990	.117
1991	.167

^aReported in square inches of ribeye area.

This project will be continued with carcass data collected from more sire progeny groups. However, sufficient variation seems to occur between sire groups to make changes in carcass traits. At this point, the ultrasound-measured ribeye area EPD appears to be a reasonably good indicator of progeny carcass REA.

Table 2. Sire EPD and Accuracy of (ACC) for Ribeye Area and Average for Carcass Traits of Their Progeny

Sire	Sire		Progeny		
	EPD	ACC	No.	REA sq. in.	Hot Carcass wt, lb
250W	.28	.031	11	12.3 ^{yz}	697 ^z
409W	-.011	.031	10	12.2 ^{yz}	696 ^z
548W	-.01	.031	9	12.7 ^{xyz}	724 ^{yz}
772X	.087	.069	8	13.2 ^{xy}	685 ^z
EO	.04	.89	44	12.1 ^z	702 ^z
392X	.66	.078	14	11.9 ^z	706 ^{yz}
59Y	.53	.51	52	13.3 ^x	743 ^y
71Y2	.10	.74	20	12.1 ^{yz}	728 ^{yz}

Sires	Progeny			
	Quality grade ^a	Adjusted fat, in.	KPH, %	Yield grade
250W	Sel 37 ^z	.36 ^z	2.24 ^z	2.6 ^z
409W	Ch- 02 ^x	.53 ^{xy}	2.53 ^{yz}	3.1 ^{xyz}
548W	Sel 67 ^{yz}	.47 ^{xyz}	2.32 ^{yz}	2.8 ^{xyz}
772X	Sel 70 ^{xyz}	.51 ^{xyz}	2.59 ^{yz}	2.7 ^{yz}
EO	Sel 86 ^{xy}	.53 ^{xy}	2.31 ^z	3.1 ^{xy}
392X	Sel 87 ^{xy}	.61 ^{xy}	2.09 ^z	3.3 ^x
59Y	Sel 60 ^z	.47 ^{yz}	2.18 ^z	2.7 ^z
71Y2	Sel 58 ^z	.50 ^{xyz}	2.70 ^y	3.2 ^{xy}

^aSel = Select, Ch- = low choice. The numerical value is the percent of way to the next grade.

^{xyz}Values in the same column with different superscripts are significantly different (P < .05).

KPH = % kidney, pelvic, and heart fat.

FACTORS INFLUENCING THE PRICE PAID FOR BULLS AT CENTRAL TEST STATIONS IN KANSAS FROM 1988-1992

D. D. Simms and J. R. Schwenke¹

Summary

Results of 13 sales of Angus (n= 185) and Simmental (n= 544) bulls at central bull tests in Kansas from 1988 through 1992 were analyzed to determine the relationship between performance and the price received. The Kansas bull test index (based 50% on weight-per-day-of-age and 50% on test ADG) was the most significant single factor determining price in both Angus and Simmental bulls. Birth weight, final weight, and frame score were other major contributors to price in Angus bulls, whereas weaning weight ratio, birth weight, and being polled were important in Simmental bulls. Expected progeny differences made small but significant ($P < .05$) contributions in Angus bulls but not in Simmental bulls.

(Key Words: Bull Tests, Expected Progeny Differences.)

Introduction

Bull buyers at central test stations in Kansas are provided with a wealth of information, including preweaning and on-test performance and expected progeny differences (EPDs), by the breed associations. Additionally, buyers visually appraise the bulls and consider other factors such as color, disposition, and breeder reputation. This analysis was conducted to determine what information commercial bull buyers use in deciding a bull's value.

Experimental Procedures

The data we analyzed were collected from the Beloit and Potwin bull tests conducted from 1988 through 1992 - a total of 13 tests. This period was selected because EPD were first provided for a majority of the bulls in 1988. Only the Angus (n= 185) and Simmental (n= 544) breeds were analyzed because numbers in the remaining breeds were considered too small to allow meaningful conclusions. The Angus and Simmental data were analyzed separately because we felt buyers might be selecting for different traits between breeds and because EPDs can't be compared from breed to breed at the current time.

The factors considered in this analysis are shown in Table 1. Other information provided to buyers but not considered includes: breeder, birth date, pedigree, weaning contemporaries, and calving ease EPD for Simmental bulls. The calving ease EPDs weren't considered because of a change in the method of calculation by the breed association during the time period covered in this study.

To avoid differences between tests in performance and prices because of weather, changes in the cattle market, and other factors, the performance and price information were standardized across tests prior to analysis. The EPDs used in the analysis were those published in the final report; pedigree or interim EPD estimates were provided by the respective breed associations. These EPD estimates took into account the actual birth and weaning

¹Department of Statistics.

weights but not the actual yearling weight performance of the bulls.

The index used in the Kansas central bulls tests is based 1/2 on the weight-per-day-of-age (WDA) and 1/2 on the ADG of the bull on test. The top 50% of the bulls on index are sold in index order.

Although determining the impact of a single factor on the price of bulls would seem to be a simple process, it is extremely difficult because of the many relationships between traits. For example, there are high correlations within growth traits such as birth weight, weaning weight, and yearling weight. There are also moderate correlations between these traits and the growth EPDs. Numerous multiple regression models were evaluated to determine which specific items of information were significant and what their contribution was to the final price received.

Results and Discussion

Table 2 shows the percentage of the total price variation accounted for by all of the significant ($P < .05$) variables in Angus bulls. Of the over 15 variables considered, only seven were significant. Again, it should be noted that these items are correlated to many of the other items considered. For example, the index is a composite of the ADG and WDA and is a good overall measure of performance. Consequently, neither ADG nor WDA was significant individually in the final model. Our model contained all of the performance information and EPDs but could account for only 30% of the variation in price. This means that other factors, such as visual appraisal and breeder reputation, were major contributors to the final price.

The changes in price for each unit of change in the significant variables are also shown in Table 2. These values represent the linear regression coefficients from the model containing all of the significant ($P < .05$) variables. Although the relationships between items of performance information make it difficult to determine the exact impact of any

one item, these estimates of the price differentials paid for each unit of change give an indication of factors that commercial bull buyers consider important.

A summary of significant variables and price differentials for the Simmental bulls is shown in Table 3. The index was again the most important single piece of information to buyers, followed by the weaning weight ratio. The polled trait and percentage Simmental were also significant. None of the EPDs accounted for a significant portion of the variation in price. As with the Angus bulls, birth weight and final weight were important variables.

Considering over 15 items of performance information, the best model could account for only 24% of the variation in price. Again, factors other than performance and EPDs are major contributors to price. In addition to visual appraisal and breeder reputation (as noted for the Angus), color undoubtedly has been a significant factor for Simmental bulls.

Although it appears that the performance information accounts for a percentage of the variation in price in both breeds, it should be noted that producers may be using the performance information, but selecting in different directions. For example, some producers may be selecting for high yearling weight EPDs, whereas others may select against very high yearling weight EPDs to moderate cow size. Because our analysis evaluated linear relationships, the model appears to ignore yearling weight EPDs, even though the breeders may have been making use of the information.

Breeders should use caution in interpreting the price differentials shown in Tables 2 and 3 because this information represents only commercial cattlemen's preferences for 1988 to 1992. For example, frame score was a significant variable in Angus bulls, but given the current interest in moderating cow size, that factor may become much less important in the future. In fact, it is conceivable that producers many actually select against extremely large framed bulls.

This study clearly shows that EPDs haven't been emphasized by commercial bull buyers in the past 4 years at central bull test sales. Because research has shown that EPDs are several times more accurate in

predicting progeny performance than the individual bull's actual performance, producers should use EPD in making bull selections.

Table 1. Performance and Descriptive Information Considered in the Analysis of Factors Influencing Price

<u>Performance Information</u>	<u>Descriptive Information</u>
Birth weight	Frame score
Adjusted weaning weight	Horn status
Weaning weight ratio	Percent Simmental
Weight per day of age	
Weight per day of age ratio	<u>Expected Progeny Differences</u>
Index	Birth weight
Yearling weight	Weaning weight
Final weight (off test)	Yearling weight
Final ADG	Maternal
Final ADG ratio	Milk

Table 2. Variation in the price of Angus Bulls Sold at Kansas Central Bull Tests Accounted for by the Performance Information Provided to Buyers and Price Differentials for Significant Factors

Item	Percentage of variation in price accounted for	Cumulative percentage	Unit	Change in the price received per unit, \$
Index	11.6	11.6	%	33.56
Birth weight	4.9	16.5	lb	-16.39
Final weight	4.0	20.5	lb	2.00
Frame score	3.2	23.7	Frame score	203.90
Milk EPD	2.2	25.9	lb	17.68
Birth weight EPD	2.1	28.0	lb	-143.87
Yearling weight EPD	1.9	29.9	lb	12.90
Total for all significant (P < .05) information		29.9		

Table 3. Variation in the Price of Simmental Bulls sold at Kansas Central Bull Tests Accounted for by the Performance Information Provided to Buyers and Price Differentials for Significant Factors

Item	Percentage of variation in price accounted for	Cumulative percentage	Unit	Change in the price received per unit, \$
Index	12.8	12.8	%	31.60
Weaning weight ratio	3.6	16.4	%	21.46
Birth weight	2.9	19.3	lb	-15.03
Polled	2.5	21.8		210.78
Final weight	1.0	22.8	lb	.97
Percentage Simmental	.9	23.7		
Total for all significant (P < .05) information		23.7		

THE RELATIONSHIPS OF COLOR TO PERFORMANCE AND CARCASS TRAITS IN CATTLE

*K. M. Andries, R. R. Schalles, M. E. Dikeman,
and D. E. Franke¹*

Summary

The effects of primary color (black, red, or white) on performance and carcass characteristics of 253 cross-bred calves were evaluated. The only effect of color was that white calves had lighter birth weights than red calves, which was probably the result of the maternal influence of the Brahman breed. White calves also had a lower carcass yield grade than red calves. No other effects of color on performance or carcass traits were found. It can be concluded that knowledge of breed and expected progeny differences (EPD) of the sire within the breed are more accurate methods of predicting the future performance and carcass characteristics of calves than color.

(Key Words: Cattle Color, Performance, Carcass.)

Introduction

Cattle buyers have often used hair color as an indicator of future performance and carcass merit. Cow-calf producers have seen calves that were half or three-quarter sibs bring different prices because they were different colors. The purpose of this study was to evaluate the relationship of color of animals to performance and carcass characteristics. This study is part of the NC-196 national project to study the genetics of body composition of beef cattle.

Experimental Procedures

Crossbred steers were produced in 1989-91 from the fifth generation of 2-, 3-, and 4-breed rotational crossbreeding systems involving Angus(AN), Hereford(HH), Charolais(CH), and Brahman(BR) breeds at Louisiana State University, Baton Rouge. Half of each cow breed group was bred to Gelbvieh(GV) bulls as a terminal cross. The remaining cows were mated to the least related breed of bulls within the rotation. Calves were born between Jan. 31 and April 14 and weaned at an average age of 185 days. At weaning, steer calves were randomly assigned, within breed group, to either a calf feeding or yearling feeding management system. After an approximate 3-week conditioning period, the calf management group was shipped to KSU, placed in the feedlot, and stepped up to a high concentrate ration (90% concentrate) over the next 3 weeks. Steers in the yearling management group were grazed on rye grass pasture in Louisiana and shipped to KSU in early May. They were also placed on a high concentrate ration similar to the calf management group. The primary color of black, red, or white was recorded at one of the normal weighings every 28 days. Color was not recorded for the calf management group from the 1989 birth year, giving a total number of 253 head available for the analysis. Half of each breed group in each management system was slaughtered when ultrasound-measured back

¹Department of Animal Science, Louisiana State University, Baton Rouge, LA.

fat was between .3 and .4 in., and the other half was slaughtered when backfat was between .5 and .6 in. Carcass data were collected after 24 hr in the cooler.

Least squares means by basic color were calculated, with the effects of percentage of each breed, management group, year of birth, and days of age removed.

Results and Discussion

Because the steers varied from zero to 67% of the AN, HH, CH, and BR breeds and this was the fifth generation, all three primary colors were represented in most breed groups. This allowed the separation of color effects from the effects of percentage of breeding (1992 KSU Cattlemen's Day Report).

The only traits for which a difference was found between colors were birth weight and carcass yield grade. Because BR, which is predominantly white, was included in most of the cow breed groups, we were unable to separate the BR maternal breed effect for light birth from the color of calf effect. This probably accounts for white calves having the lightest birth weight. White calves also had a lower yield grade than red calves.

Color of calf had no other effects on performance or carcass traits. It can be concluded that knowledge of breed and expected progeny differences (EPD) of the sire within the breed are more accurate methods of predicting the future performance and carcass characteristics of calves than color.

Table 1. Least Squares Mean Performance and Carcass Traits by Animal's Basic Color

Trait	Basic Color		
	Black	Red	White
Birth weight (lb)	80 ^{yz}	83 ^y	77 ^z
Weaning weight (lb)	497 ^z	513 ^z	562 ^z
Feedlot ADG (lb)	2.47 ^z	2.56 ^z	2.44 ^z
Carcass weight (lb)	731 ^z	754 ^z	734 ^z
Backfat (in.)	.42 ^z	.46 ^z	.40 ^z
Ribeye area (in. ²)	13.3 ^z	13.0 ^z	13.4 ^z
Yield grade	2.58 ^{yz}	2.76 ^y	2.48 ^z
Quality grade ^a	Sel 91 ^z	Sel 90 ^z	Sel 94 ^z

^aSel is select grade and the numerical value is the percent of the way to choice grade.

^{yz}Means in the same row with different superscripts are different (P < .05).

FACTORS AFFECTING PREGNANCY RATES AND CALVING DIFFICULTY IN COMMERCIAL BEEF HEIFERS

*S. D. Utter, P. L. Houghton,¹ L. R. Corah,
M. F. Spire,² J. J. Higgins,³ and M. D. Butine³*

Summary

Data from yearling Angus and Angus crossbred beef heifers from a commercial ranch were used to identify factors affecting pregnancy rates (n= 342) and calving difficulty (n= 295). Production data analyzed included prebreeding weight, average daily gain during the breeding season, and postbreeding weight; evaluations of hip height, frame score, weight:height ratio, and reproductive tract score were made at approximately 1 yr of age. Pregnancy rates were affected significantly by weight:height ratio, prebreeding weight, and reproductive tract score. However, based on correlation coefficients, the magnitude of influence of these traits on first-service conception and overall pregnancy rates was low. Calving difficulty in the same heifers (n= 295) was influenced significantly by calf birth weight, heifer yearling frame score, and average daily gain of the heifer during the breeding season. Heavier calf birth weight increased calving difficulty, whereas increases in frame score and average daily gain reduced calving difficulty.

(Key Words: Heifer Development, Pregnancy Rate, Calving Difficulty.)

Introduction

The demand for efficient production has created more intensive management of beef cattle operations. For the cow-calf producers, proper heifer development is the first step to increase efficiency within the cow herd. To determine how specific production practices can influence conception rates and calving ease in yearling heifers, data were collected from a cooperating ranch.

Experimental Procedure

Yearling Angus and Angus-cross beef heifers (n= 342) from a commercial cattle ranch were used to analyze factors affecting pregnancy rates and calving difficulty. Heifers arrived at a commercial heifer development facility at approximately 10 mo of age and were managed to attain approximately 65% of their projected mature body weight at time of breeding. Measurements, including prebreeding weight, hip height (used to calculate weight to height ratio and frame score), pelvic area, and reproductive tract score (scale 1= highly developed to 5= least development), were obtained at approximately 1 yr of age.

Estrus was synchronized by feeding melengesterol acetate (MGA) at 0.5 mg per hd/d for 14 d. A subcutaneous injection of a

¹Appreciation is expressed to Dr. Patsy Houghton and Heartland Cattle Co. for providing the data for the study.

²Dept. of Clinical Sciences, College of Veterinary Medicine.

³Department of Statistics.

prostaglandin analog was administered 17 d following removal of MGA from the diet. Heifers exhibiting behavioral estrus were inseminated artificially 12 h following visual detection of heat. Heifers that failed to respond were reinjected with the prostaglandin analog 7 d later. All heifers were observed for an additional estrous cycle and rebred if behavioral estrus was exhibited. Only artificial insemination was used during the breeding season. All heifers were bred to projected calving-ease sires.

Pregnancy was determined by ultrasound, and final weight was recorded 45 d following the conclusion of the breeding season. Final weight, sire of calf, and average daily gain of the heifers (prebreeding weight to final weight) also were used in the analysis.

Pregnancy was reconfirmed by calving results. Heifers calved at 2 yr of age ($n=295$), and birth weight, sex of calf, and degree of calving difficulty were recorded (1= unassisted, 2= pulled, 3= difficult pull, 4= Cesarean section, 5= abnormal presentation). This information, plus the previous heifer development data, was used to evaluate factors affecting calving difficulty using a stepwise regression procedure. Categorical predictive statistical models were developed for

the individual response variables by a stepwise procedure, using a backward elimination strategy. With this method, all possible relevant variables were fit to a model.

Results and Discussion

The average values for the production data used in the analysis are shown in Table 1. Overall pregnancy rate was affected by weight to height ratio ($P < .05$), which is an indication of the heifer's body condition at breeding, prebreeding weight ($P < .05$), and the reproductive tract score ($P < .07$). An increase in weight to height ratio (body condition) was correlated with an increase in pregnancy rates; increases in prebreeding weight and reproductive tract score were correlated to a slight but significant decrease in pregnancy rates. Although these traits had a significant influence on pregnancy rates, the correlation coefficients were very low, indicating that magnitude of their influence was small.

Calving difficulty was influenced by calf birth weight ($P < .01$), yearling frame score ($P < .05$), and average daily gain during the breeding season ($P < .09$). As expected, heavier calf birth weight resulted in increased calving difficulty. As frame score and average daily gain during the breeding season increased, calving difficulty was reduced.

Table 1. Average Values for Production Data Used in the Analysis

Item	Average	Standard Deviation
Production Data (n= 342)		
Prebreeding weight, lb	752.9	58.1
Final weight, lb	874.4	66.1
Total gain, lb	121.5	29.2
Avg daily gain, lb/d	1.09	.29
Reproductive tract score	2.7	.8
Frame score	4.9	.7
Weight:height ratio	2.8	.2
First-service conception rate, %	67.1	47.1
Overall pregnancy rate, %	86.6	34.1
Calving Data (n= 295)		
Yearling pelvic area, in. ²	225.3	19.4
Calf birth weight, lb	70.8	10.9
Calving ease score	1.23	.51
% calving difficulty		
1 No assistance	79.7	
2 Slight assistance	16.6	
3 Difficulty birth	3.1	
4 C-section	.3	
5 Abnormal presentation	.3	

HOW DOES COW-CALF ASSOCIATION INHIBIT THE ONSET OF ESTROUS CYCLES AFTER CALVING?

*J. S. Stevenson, J. E. Minton, E. L. Knoppel,
R. E. Stewart, S. D. Viker, and G. H. Kiracofe*

Summary

The "suckling response" maintains anestrus in beef cows for about 40 to 60 days postpartum. The suckling response remains intact in mastectomized cows, so stimulation of the inguinal area, and not milk flow or teat stimulation, must be part of the response. Cow-calf recognition is part of the suckling response because suckling by cross-fostered calves after nose-to-nose contact followed by suckling of an alien calf does not prevent cycling. We believe the suckling response involves a cow recognizing her own calf, followed by the calf stimulating her inguinal area. It may be possible to initiate estrus by simply blocking the cow's recognition of her own calf.

(Key Words: Suckling, Mastectomy, Estrous Cycles, Beef Cows.)

Introduction

Generally, cows that nurse their calves at least twice daily, similar to cows that nurse their calves ad libitum, have longer intervals to first ovulation than nonsuckled or once daily suckled cows. Presence of a nonsuckling (muzzled) calf prolonged the interval to first postpartum estrus to 58 d compared to 35 d in cows whose calves were removed 72 h after birth. Cows whose calves were fitted with nose plates to prevent suckling after 30 d, averaged 72 ± 9 d to first postpartum estrus compared to 81 ± 11 d in controls or 43 ± 10 d in cows whose calves were weaned at 30 d postpartum.

Suckled cows in which the mammary glands were denervated to remove a neural

component of the suckling stimulus had similar intervals to first postpartum estrus as intact cows with calves. Mastectomy (removal of the mammary glands) of heifers at 2 mo of age resulted in reduced postpartum intervals to ovulation during three parities compared to suckled controls (first: 32 vs 52 d; second: 21 vs 59 d; and third: 20 vs 46 d). Cows suckled by cross-fostered calves released less oxytocin during suckling than those nursing their own calf. Concentrations of luteinizing hormone (LH) were greater in cows whose calves were previously weaned or in those with cross-fostered calves. Incidence of ovulation by 12 d after onset of treatments was greater for cows with cross-fostered calves (71%) and those whose calves were weaned previously (67%) compared to cows nursed by their own calves (17%). Since 1987, our objectives have been to determine how the suckling stimulus inhibits the onset of estrous cycles after calving and what physiological components are part of this inhibitory signal. These studies were initiated by Dr. Guy Kiracofe and have continued since his departure from Kansas State University in 1991.

Experimental Procedures

Experiment 1 (1987). The objective of this study was to determine when mastectomized (Mast-X) cows would begin their estrous cycles following calf removal at birth. Bred heifers were mastectomized during early gestation after being confirmed pregnant. All mammary tissue was removed and the abdominal skin was sutured closed, with drainage catheters left in place during the postsurgical healing period. The cows were allowed to calve, and their calves were removed within 24 h of birth. Blood was collected daily to assess

changes in serum progesterone (indicative of postovulatory function of a corpus luteum), and cows were observed for signs of heat.

Experiment 2 (1988). The objective of this study was to determine whether the presence of their own calves would alter when Mast-X cows begin their estrous cycle after calving. Half of the calves remained in the presence of the cows (calf present), and the remaining calves were removed permanently at birth (calf removed). Those Mast-X cows maintained with their calves were allowed normal uninterrupted contact with their calves, except for a few minutes twice daily when calves were bottle-fed. Blood was collected daily to assess changes in serum progesterone, and cows were observed for signs of heat. In the absence of any heat activity, the calves in the calf-present group were removed permanently at 46 to 53 d of age.

Experiment 3 (1989). The objective of this study was to repeat Experiment 2 and include some normally suckled, udder-intact cows with their calves present. Additional cows were mastectomized during early gestation after confirmed pregnancy. The treatments included the same two treatments used in Experiment 2 (calf removed and calf present) plus four udder-intact cows with their calves (udder-intact + calf present). Those Mast-X cows maintained with their calves were allowed normal uninterrupted contact with their calves, except for a few minutes twice daily when calves were bottle-fed. Blood was collected daily to assess changes in serum progesterone, and cows were observed for signs of heat.

Experiment 4 (1990). The objective was to determine whether restricting the calf's contact to the head and neck of its dam (i.e., the calf could not attempt to nurse the Mast-X cow) would alter the onset of postpartum estrous cycles. Four treatment groups were formed: 1) Mast-X cow + calf present; 2) Mast-X cow + calf removed at birth; 3) Mast-X cow + calf restricted (the calf was kept in a pen adjacent to its dam so the calf could only touch and nuzzle the head and neck of its dam); and 4) udder-intact cow + calf present. Mast-X cows maintained with their calves were

allowed normal uninterrupted contact with their calves (calf present), except for a few minutes twice daily when calves were bottle-fed. Calves in the calf-restricted group also were bottle-fed twice daily. Blood was collected daily to assess changes in serum progesterone, and cows were observed for signs of heat.

Experiment 5 (1992). The objective of this experiment (same treatments as Experiment 4) was to determine how restricting the calf to the head and neck area (i.e., the calf could not attempt to nurse the Mast-X cow) or allowing unlimited suckling-like activity of the calf to its Mast-X or udder-intact dam altered normal suckling-induced hormone secretion and altered the onset of postpartum estrus. Four treatment groups were formed: 1) Mast-X cow + calf present; 2) Mast-X cow + calf removed at birth; 3) Mast-X cow + calf restricted (the calf was kept in a pen adjacent to its dam so the calf could only touch and nuzzle the head and neck of its dam); and 4) udder-intact + calf present. Mast-X cows maintained with their calves were allowed normal uninterrupted contact with their calves (calf present), except for a few minutes twice daily when calves were bottle-fed. Calves in the calf-restricted group also were bottle-fed twice daily. Blood was collected daily to assess changes in serum progesterone, and cows were observed for signs of heat. In addition, at d 7 postpartum, the calves were separated from their dams and then returned to their dams 12 h later. During that time, blood samples were collected at frequent intervals to characterize changes in serum concentrations of suckling-induced hormonal secretions (cortisol, oxytocin, and prolactin).

Results and Discussion

Results of all five experiments are summarized in Table 1. In Experiment 1, Mast-X cows whose calves were removed at birth initiated estrous cycles from 7 to 28 d after calving.

In Experiment 2, Mast-X cows with their calves present cycled approximately 5 wk later than Mast-X cows with their calves removed at birth.

In Experiment 3, Mast-X cows with their calves removed at birth began their cycles from 14 to 22 d after calving, approximately 2 to 3 wk earlier than Mast-X cows or udder-intact cows with their calves present.

In Experiments 4 and 5, results obtained were similar to those in Experiment 3. In addition, in both Experiments 4 and 5, those Mast-X cows with their calves restricted so they could not suckle their dams, cycled as early as Mast-X cows whose calves were removed at birth. After feeding, calves in the calf-present group would return to their dams and attempt to nurse the inguinal area where the intact mammary glands had been. The duration of this suckling activity was similar for calves exposed to their Mast-X (13.0 ± 2 min) or udder-intact dams (15.3 ± 2 min). Concentrations of oxytocin, normally released at suckling, were increased in both Mast-X and udder-intact dams when calves rejoined their dams after a 12-h separation. Concentrations of prolactin also

tended to increase in the Mast-X or udder-intact cows when exposed to their calves after this separation.

These results indicate that the presence of mammary glands was not essential for the suckling signal to prolong anestrus in beef cows. Furthermore, because Mast-X cows in the calf-restricted groups cycled as early as those whose calves were removed at birth, the calf must provide some tactile stimulation to the cow's inguinal area in order to prolong anestrus. We believe the suckling signal is two-part. For the suckling signal to be complete, the cow must recognize her calf, and her own calf must then attempt to nurse. This cow-calf recognition is a critical part of the inhibitory signal, because cross-fostered calves brought nose-to-nose with cows and then allowed to nurse, failed to complete the suckling signal (estrous cycles begin as if the cows were not nursed). Therefore, the process of cow-calf recognition must precede the suckling event in order to complete the inhibitory signal. It seems plausible that, if we can block cow-calf recognition, then the cow would begin to cycle despite continued suckling activity of her own calf. This hypothesis remains to be tested.

Table 1. Days to First Postpartum Ovulation Based on Progesterone in Serum

Treatment	Exp. 1 (1987)	Exp. 2 (1988)	Exp. 3 (1989)	Exp. 4 (1990)	Exp. 5 ^a (1992)
Mast-X + calf removed	13.9 7 to 28 ^c (n = 11)	16.0 14 to 22 (n = 4)	15.2 9 to 21 (n = 4)	17.0 12 to 30 (n = 7)	23.6 10 to 38 (n = 8)
Mast-X + calf restricted ^b				15.3 8 to 25 (n = 7)	29.1 17 to 41 (n = 7)
Mast-X + calf present		49.0 ^d 50 to 54 (n = 4)	37.0 19 to 56 (n = 11)	30.4 15 to 42 (n = 7)	36.7 29 to 48 (n = 7)
Udder-intact + calf present			28.2 23 to 32 (n = 4)	28.6 18 to 44 (n = 7)	40.7 37 to 46 (n = 8)

^aCalves were removed from their dams on d 35 postpartum.

^bCalf was maintained in smaller pen within the individual cow pen with the cow receiving only access to the head and neck of its dam (i.e., calf could not suckle its dam).

^cRange of days postpartum.

^dCalves were removed from cows at 46 to 53 d postpartum and cows ovulated 1 to 4 d later.

USE OF CYSTORELIN® AND ARTIFICIAL INSEMINATION IN REPEAT-BREEDING BEEF HEIFERS AFTER ESTROUS SYNCHRONIZATION¹

J. P. Hotz², P. L. Houghton³, and M. F. Spire⁴

Summary

Gonadotropin-releasing hormone (GnRH) was administered to a group of 13- to 14-month-old Angus and Angus crossbred repeat-breeding heifers at the time of the second or third artificial insemination to determine its effect on conception rates. Little benefit was derived from the use of GnRH at either second or third service in highly developed repeat-breeding heifers.

(Key Words: Gonadotropin-Releasing Hormone, Repeat Breeders, Conception Rate, Beef Heifers.)

Introduction

GnRH is a naturally occurring hormone that is synthesized in an area of the brain called the hypothalamus and is a component of a complex series of hormonal interactions preceding ovulation. As pulses of GnRH are released from the hypothalamus, it stimulates the pituitary gland to produce surge-like secretions of follicle-stimulating hormone (FSH) and luteinizing hormone (LH), which are released into the bloodstream to act on the ovaries. The magnitude of the induced surge of LH is then sufficient to stimulate ovulation in cattle and sheep. Ovulation normally

occurs 24 to 30 hours after the start of behavioral estrus. An injection of GnRH at the time of breeding (12 hours after first observed behavioral estrus) theoretically should result in a large surge of LH, resulting in ovulation and increased chances for conception.

Estrous synchronization programs at Kansas State University using melengestrol acetate (MGA) and prostaglandin F_{2α} have demonstrated 65% to 79% behavioral estrus by 6 days after prostaglandin administration. First-service conception rates have ranged from 58% to 81%. Clinical trials and on-ranch experience, however, show a marked decrease in second-service conception rates. The physiological reason is unknown.

Previous research with dairy cattle has demonstrated that GnRH administration results in up to 20% higher conception rates in repeat-breeders (more than two services). Little benefit was noted at first or second services. However, there is little information detailing conception rates following the use of GnRH at the time of service in second- or third-service beef heifers.

¹Authors sincerely appreciate the assistance of Sharon Tucker and Heartland Cattle Company in conducting this trial.

²Department of Clinical Sciences.

³Heartland Cattle Company, McCook, NE.

⁴Department of Clinical Sciences.

Experimental Procedures

Five-hundred and eight 13- to 14-month-old Angus and Angus crossbred heifers were developed uniformly in a drylot heifer operation. Each heifer underwent a prebreeding evaluation consisting of reproductive tract scoring (1 = > 25mm horn diameter, 5 = < 10mm horn diameter), pelvimetry, and weight and frame score determinations. Any heifer determined unlikely to be cycling at the time of breeding was culled. Estrus was synchronized using a 14-day regimen of MGA fed at a level of 0.5 mg/head/d, followed 17 days later by the administration of an analog of prostaglandin $F_{2\alpha}$. All heifers were inseminated artificially 12 hours after first observed signs of estrus using a single unit of semen from either of four sires. Sires were selected on the basis of their genotypic and phenotypic characteristics and those of individual heifers. Heifers were observed twice daily for return to estrus following the initial insemination. Those heifers that returned to estrus were assigned randomly to either a control group, which received an intramuscular injection of 2 ml of sterile saline at the time of breeding, or a treatment group, which received an intramuscular injection of 100 μ g of GnRH (Cystorelin[®]) in 2 ml of saline at the next estrus and insemination after the synchronized heat. This group of second-service heifers was again observed twice daily for signs of estrus. Of the heifers returning to estrus a third time, those in the control group for the second service were placed in the GnRH-treatment group for the third service. Those heifers in the treatment group for the second service were placed in the control group for the third service. All heifers were again inseminated 12 h after first detected estrus using a single unit of semen from a predetermined sire, and at the time of insemination, received either saline or Cystorelin. All pregnancies were confirmed using a B-mode, real-time, linear array, ultrasound system 45 days following the third breeding.

Results and Discussion

Following the first insemination at the synchronized heat, 396 of 508 heifers were pregnant, with a resulting pregnancy rate of 71.7%. Of the remaining 112 heifers that returned to estrus a second time, 58 received GnRH and 54 (control) received saline at the time of the second service. Only a slight difference was apparent in the conception rates between these two groups. Of those heifers receiving the GnRH, 76% became pregnant compared to 74% in the control group.

Of the 28 heifers that failed to conceive to either of the first two services, three did not return to estrus a third time and were removed from the program. Within the third-service, GnRH-treatment group, nine heifers (75%) became pregnant compared to seven heifers (54%) in the control group.

Our results for second-service beef heifers are consistent with previous studies on second service, repeat-breeding, dairy cattle; there was little benefit from GnRH. Although our 22% increase in conception rates in third-service beef heifers receiving GnRH seems to indicate a benefit, the results may be misleading because of the small number of third services. The heifers in our study were well-developed, which may have led to their high first-service conception rates. GnRH may prove to be of greater value in groups of lower producing, repeat-breeding heifers whose first-service conception rates are 50% or less.

REPRODUCTIVE PERFORMANCE OF YEARLING BEEF HEIFERS AFTER ESTRADIOL BENZOATE AND ESTROUS SYNCHRONIZATION¹

R. P. Bolze and C. W. Peters

Summary

Injectable estradiol (estradiol benzoate) was evaluated for its effect on the reproductive performance of yearling beef heifers whose estrous cycles were synchronized using the melengestrol acetate/prostaglandin F₂α (MGA®/PG) system. Estradiol was injected 40 h after prostaglandin. Heifers were inseminated artificially (AI) 12 h after first observed heat during a 35-d AI period followed by 28 d of bull exposure. Estradiol had no effect on heat response or first-service pregnancy rate to AI during the synchronized period (5 d) and had no significant effect on overall AI pregnancy rate (35 d), cumulative pregnancy rate (63 d), or average calving date. In summary, estradiol benzoate had no effect on the reproductive efficiency of yearling beef heifers whose estrous cycles were synchronized with the MGA/PG system.

(Key Words: Beef, Heifer, Estrous Synchronization, MGA, Prostaglandin, Estradiol Benzoate.)

Introduction

Estrous synchronization prior to artificial insemination (AI) can shorten breeding and calving seasons and increase calf weaning weights. Earlier experiments conducted by KSU animal scientists have shown that the MGA/PG estrous synchronization system is effective in increasing the number of heifers conceiving after AI. In some of the early PG synchronization research, West Virginia

researchers found that an injection of estradiol benzoate at 40 to 48 h after PG improved heat expression, conception rate after AI, and overall pregnancy rate in yearling beef heifers and lactating beef cows. Therefore, our objective was to evaluate the effect of combining injectable estradiol in an MGA/PG estrous synchronization system on heat response and pregnancy rate in yearling beef heifers.

Experimental Procedures

A total of 101 fall-born heifers from a central Kansas Simmental ranch received MGA (.5 mg per head/d) for 14 d, with PG (Bovilene®) injected intramuscularly 17 d after the last MGA feeding. At the time of PG injection, blood was collected for serum progesterone analysis. At 40 h after PG injection, heifers were allotted, based on age and weight, to receive one intramuscular injection of either 1) 2 ml of corn oil or 2) 2 ml of corn oil containing 400 µg of estradiol benzoate.

Heifers were inseminated 12 h after first detected estrus. A few heifers that showed estrus less than 40 h after PG injection were removed from the experiment. A second PG injection was given 10 d following the first PG injection to heifers that had not yet shown estrus. Artificial insemination 12 h after observed heat continued for 35 d, followed by 28 d of exposure to a single sire (63-d breeding season). Pregnancy was determined by palpation of the uterus 50 to 100 d after AI.

¹Appreciation is expressed to Dickinson Simmental Ranch, Gorham, KS for cooperating with this project.

First-service pregnancy rate was verified by actual calving dates.

Results and Discussion

Table 1 summarizes the effect of estradiol on the reproductive performance of fall-born yearling Simmental heifers whose estrous cycles were synchronized with the MGA/PG system. Only 79% of the heifers were puberal (serum progesterone > 1 ng/ml) at the start of the breeding season. Similar percentages of puberal heifers were in estradiol and control groups (78 vs 80%). Average

serum concentrations of progesterone (4.82 vs 6.14 ng/ml) were similar for control and estradiol-treated heifers, respectively. Estradiol benzoate had no effect on the percentage of heifers showing estrus or on first-service AI pregnancy rate, overall AI pregnancy rate, cumulative pregnancy rate, or average calving date.

In conclusion, injecting yearling beef heifers with 400 µg of estradiol benzoate 40 h after PG injection in an MGA/PG estrous synchronization system failed to further improve their reproductive performance.

Table 1. Effect of Estradiol Benzoate on Reproductive Performance of Yearling Simmental Heifers Estrous Synchronized with the MGA/PG System

Item	Control	EB ^a
No. of heifers	50	51
Puberty ^a	78% (39/50)	80% (41/51)
Avg progesterone, ng/ml	4.82	6.14
Heat response during synchronized period (5 d)	66% (33/50)	73% (37/51)
First-service pregnancy rate during synchronized period (5 d)	64% (21/33)	65% (24/37)
Overall AI pregnancy rate (35 d)	68% (34/50)	78% (40/51)
Cumulative pregnancy rate (63 d) ^b	78% (39/50)	88% (45/51)
Average calving date	Sept. 24	Sept. 25

^aEstradiol benzoate.

^bHeifers with serum concentrations of progesterone > 1 ng/ml at the time of PG injection.

^cIncludes heifers that were inseminated and bull-bred.

PROGESTERONE CONCENTRATIONS, ESTROUS RESPONSE, AND FERTILITY IN BEEF HEIFERS AFTER ESTROUS SYNCHRONIZATION USING MELENGESTROL ACETATE® AND PROSTAGLANDIN F₂α¹

C. W. Peters, R. L. Larson², and L. R. Corah

Summary

Melengestrol acetate (MGA®) and prostaglandin F₂α (PG; Lutalyse®) were used to synchronize estrus in 757 yearling, virgin, beef heifers on six commercial ranches. Heifers were inseminated artificially (AI) 12 h after first detected estrus; those not detected in estrus were time-inseminated 72 h post-PG injection. Heifers detected in estrus by 72 h had higher AI and overall pregnancy rates than their counterparts not detected in estrus. Heifers with serum progesterone > 1 ng/ml at PG administration were generally more fertile than those with progesterone < 1 ng/ml. Of the heifers not detected in estrus and with low progesterone (< 1 ng/ml), 24% still conceived to the timed insemination at 72 h, but only 73% became pregnant during the entire breeding period. Overall AI conception rate, based on estrous detection and timed insemination, was 49% and varied from 24% to 69% among the six ranches. Heifers exhibiting estrus and with elevated (> 1 ng/ml) serum progesterone showed acceptable pregnancy rates (63% AI and 94% overall).

(Key Words: Melengestrol Acetate, Prostaglandin, Beef Heifers, Fertility, Estrus, Progesterone.)

Introduction

Estrous synchronization has been a popular and profitable tool for producers in recent years. Research at KSU has focused on combining melengestrol acetate (MGA) and prostaglandin F₂α (PG) to synchronize effectively estrus in virgin beef heifers. Successful synchronization reduces the length of the breeding period, shortens the calving season, and allows the effective use of AI. Along with reduced labor and older, heavier calves at weaning, selecting appropriate AI sires can minimize calving difficulty in virgin heifers and offer exceptional replacement females. However, substantial variation can occur in estrous response and fertility with MGA/PG synchronization. Our objective was to determine the relationships among estrous activity, serum concentrations of progesterone, and fertility in yearling beef heifers.

Experimental Procedures

During the spring of 1991 at six Kansas ranches, estrus of 757 yearling beef heifers was synchronized using MGA and PG. MGA was fed at .5 mg per hd/d for 14 d in a feed supplement. Then MGA was removed and 17 d later, each heifer received an

¹Authors are grateful to the following Kansas cow-calf producers for their cooperation and patience in conducting this research: Jack and Alan Grothusen, Ellsworth; Gary Johnson, Dwight; Wayne Miller, Quinter; Kelly Moser, Manhattan; Dean Perkins, Barnes; Leo Rader, Frankfort.

²Present address: Carthage Veterinary Clinic, Carthage, IL.

intramuscular injection of 25 mg PG. At the time of the PG injection, blood samples were taken for progesterone analysis. Beginning 12 h after PG, heifers were checked for behavioral estrus each morning and night and inseminated 12 h after estrus was observed. Any heifer not detected in estrus was time-inseminated at 72 h after PG. Heifers were exposed to bulls approximately 10 d following the timed insemination; bulls remained with heifers for 45 to 75 d. Heifers were palpated for pregnancy and fetal age 45 to 60 d after bulls were removed. Overall pregnancy rates to AI and natural mating were calculated and confirmed from calving data. Pregnancy data were available on 620 heifers.

Results and Discussion

Table 1 demonstrates that more heifers bred after estrus conceived (60%) than heifers that did not show estrus and were time-inseminated 72 h after PG (32%). Pregnancy rate was 49% for all heifers bred AI (both estrus and time inseminated). Overall pregnancy rate (AI plus clean-up bulls) also favored heifers that exhibited estrus by 72 h (92%) compared to those that were time inseminated (80%).

Heifers conceiving to AI (estrus + time-insemination) had higher ($P < .001$) concentrations of serum progesterone at the time of PG injection than heifers not conceiving to AI (2.6 vs 2.0 ng/ml). Heifers pregnant at the end of the breeding period (AI + natural service) had higher ($P < .001$) serum progesterone at PG injection than nonpregnant heifers (2.4 vs 1.6 ng/ml).

Table 1 details also the effect of progesterone concentration at the time of PG injection on AI and overall pregnancy rate. More heifers conceived to AI (56 vs 33%) and were pregnant at the end of the breeding season (91 vs 77%) when they had serum progesterone > 1 ng/ml compared to heifers

with serum progesterone < 1 ng/ml. Synchronization improved fertility less in heifers with serum progesterone > 2 ng/ml than in heifers with progesterone from 1 to 2 ng/ml.

Theoretically, all heifers fed MGA for 14 d and injected with PG 17 d later should have possessed a functional corpus luteum (CL). This is documented by high concentrations of serum progesterone, generally > 1 ng/ml. Heifers with serum progesterone < 1 ng/ml would be less likely to have a functional CL and less likely to respond to PG. However, 24% of the heifers that did not exhibit estrus still conceived to AI when serum progesterone was < 1 ng/ml at the time of the PG injection. Of those with progesterone less than 1 ng/ml at the time of PG injection that were detected in estrus, 46% conceived to AI mating.

Table 1 shows the relationship of combined estrus and progesterone status on fertility. First-service AI conception rate in heifers that exhibited estrus and had an elevated serum progesterone was acceptable at 64%. Overall pregnancy rate was lowest for heifers that did not exhibit estrus and also had low serum progesterone (73%). Heifers that both exhibited estrus and had high serum progesterone had an overall pregnancy rate of 94%. These results support the importance of using AI following both heat detection and timed insemination at 72 h. Without timed insemination, 76 heifers (25% of all heifers bred AI) would not have conceived to AI. Nearly 50% of all heifers conceived to AI, an acceptable level in most cattle operations.

Table 2 shows the wide variability in pregnancy rates that can occur among different locations. Conception rate to AI varied more than twofold among different ranches, whereas overall pregnancy rate ranged from 75 to 97%. These differences in fertility could be due to differences in heifer development, management, AI technicians, or fertility of clean-up bulls.

Table 1. Fertility in Beef Heifers Synchronized with Melengestrol Acetate and Prostaglandin F₂α

Item	Pregnancy rate ^a			
	AI, %	No.	AI+ bull, %	No.
Time to estrus				
In estrus by 48 h post-PG ^b	56	70/125	89	111/125
In estrus 48 to 72 h post-PG	63	156/249	94	233/249
Time inseminated (72 h)	32	76/239	80	191/239
Serum progesterone				
P ₄ > 1 ng/ml ^c	55	253/456	91	416/456
P ₄ > 1 ng/ml	33	54/164	77	126/164
P ₄ 1 to 2 ng/ml	50	66/132	89	117/132
P ₄ > 2 ng/ml	58	187/324	92	299/324
Estrus and progesterone level				
No estrus, < 1 ng/ml P ₄ ^d	24	23/97	73	71/97
Estrus, < 1 ng/ml P ₄	46	31/67	82	55/67
No estrus, > 1 ng/ml P ₄	37	53/142	84	120/142
Estrus, > 1 ng/ml P ₄	64	195/307	94	289/307

^aAI = artificial insemination.

^bPG = prostaglandin F₂α.

^cP₄ = serum progesterone.

^dNo estrus = heifers not detected by 72 h after prostaglandin F₂α; Estrus = heifers detected in estrus by 72 h.

Table 2. Variability among Ranches in Estrus Response and Fertility of Beef Heifers Synchronized with Melengestrol Acetate and Prostaglandin F₂α

Item	A ^a	B	C	D	E	F
Total number of heifers	74	189	202	77	92	123
Detected in estrus by 72 h after prostaglandin injection						
%	76	81	42	53	59	59
No.	53/70	151/187	85/201	41/77	54/91	73/123
Conceived to AI when detected in estrus ^b						
%	74	73	32	70	54	NA ^c
No.	39/53	103/142	27/85	28/40	29/54	NA
Conceived to AI of total (estrus and time inseminated)						
%	64	69	24	71	37	NA
No.	47/74	125/180	49/202	53/75	33/89	NA
Overall pregnancy rate						
%	91	97	75	91	92	NA
No.	67/74	174/180	151/202	68/75	82/89	NA

^aThe six ranch locations are denoted by the letters A through F.

^bAI = artificial insemination.

^cNA = not available.

LUTEINIZING HORMONE RELEASE AND PLASMA METABOLITES IN MATURE, OVARIECTOMIZED BEEF COWS FED VARIOUS LIPID DIETS¹

*C. W. Peters, L. R. Corah, R. C. Cochran,
J. S. Stevenson, and J. E. Minton*

Summary

Feeding rumen-escape lipid or soybean oil in a range supplement to beef cow resulted in elevated blood cholesterol and enhanced luteinizing hormone (LH) release compared to a control (milo and soybean meal) supplement. Cholesterol was elevated ($P < .01$) within 14 d of lipid feeding. The amplitude of each LH pulse and maximal pulse height were greater ($P < .05$) when cows were fed high-lipid diets. The positive influence of high-lipid diets on reproductive function may be explained in part by enhanced LH release.

(Key Words: Beef Cows, Lipid, Luteinizing Hormone, Cholesterol, Reproduction.)

Introduction

Lengthened postpartum anestrus delays resumption of cyclicity and may increase calving intervals above the goal of 365 d. Incorporating lipid into range supplements fed during the postpartum period has been shown to enhance reproductive function. When cows conceive earlier in the breeding season, calves are heavier at weaning, and yearly calving intervals are achieved. The positive influence of high-lipid diets may be at the level of the ovary (follicular growth, steroid production) or at the level of the hypothalamus and pituitary (gonadotropin release). Our objective was to determine pituitary response, particularly characteristics of luteinizing hormone (LH) release, to high-lipid diets fed to beef cows.

Experimental Procedures

Six ovariectomized, Angus \times Hereford, mature cows [avg age = 5 yr; avg wt = 1043 lb; avg body condition score = 5.9 (1 = emaciated, 9 = extremely obese)] served as experimental units in a 6×6 Latin square experiment. A 2×3 factorial arrangement of treatments was employed consisting of estradiol-17 β implanted or nonimplanted cows with three dietary supplements: 1) control (milo + soybean meal); 2) rumen-escape lipid (milo + soybean meal + Megalac[®]); and 3) soybean oil (milo + soybean meal + soybean oil). Megalac is a rumen-escape lipid composed of calcium salts of palm oil fatty acids. Dietary treatments were designed to compare high-lipid supplements to a control supplement along with comparing rumen-escape lipid (Megalac) to nonescape lipid (soybean oil).

Estradiol produced by the ovary can provide feedback to the hypothalamus and pituitary and alter the release of LH. The purpose of removing the ovaries in this study was to determine the interaction of estrogen and lipid on LH release. By implanting estradiol, we were able to achieve a controlled, constant estradiol level as opposed to the fluctuating levels present in ovary-intact cows. Megalac and soybean oil replaced milo in the control supplement; all supplements were formulated to be isocaloric and isonitrogenous (20% crude protein), with equivalent levels of calcium and phosphorus. The remainder of the diet consisted of native prairie hay fed according to body weight to meet NRC (1984) requirements. Each period of the Latin square

¹The authors are grateful to J. Grund and R. Michaelis for assistance with data collection.

was 21 d with a 4 d rest between periods. On d 0 of each period, three cows received four silastic implants containing crystalline estradiol. Implants were placed subcutaneously immediately in front of the shoulder. The remaining three cows received no implants. Jugular blood samples were collected on d 0 and every other day throughout the period. Beginning on d 0, diets were fed once daily for 21 d. On d 20, all cows were fitted with jugular catheters to facilitate blood collection to measure LH. Samples were collected on d 21 for 8 h at 6-min intervals. On d 22, implants were removed and all cows received the control supplement for 4 d, after which the next period began. Body weight and condition scores were determined at the completion of each period. Serum samples were assayed for estradiol and LH and plasma samples were analyzed for cholesterol, triglycerides, blood urea nitrogen, glucose and total protein. Pulsatile characteristics of LH [peak amplitude, maximum peak height, baseline value excluding peaks and pulse frequency (number of pulses during 8 h)] were determined using a computer program called PC-Pulsar, combined with visual graph analysis of individual profiles.

Results and Discussion

Presented in Table 1 are data for body weight and condition score changes. Cows without estradiol implants gained more ($P = .02$) weight during each period; however, condition score changes were not

consistent. Estradiol implants elevated ($P < .01$) serum estradiol (.5 vs 15.5 pg/ml), but dietary treatments had no effect.

Detailed in Table 2 are data regarding LH release. Peak amplitude and the maximal height of each LH pulse were enhanced ($P < .05$) by feeding both high-lipid diets. Nonescape lipid tended ($P = .09$) to enhance peak amplitude more than rumen-escape lipid. Pulse frequency of LH was lower ($P < .01$) in cows that received estradiol implants than in nonimplanted controls (see also Figure 1). Figure 2 depicts the enhanced release of LH by cows fed lipid supplements compared to cows fed the control supplement.

As expected, cholesterol was elevated ($P < .01$) in cows receiving either high-lipid diet (Table 3). Nonescape (soybean) lipid produced the highest plasma cholesterol in nonimplanted cows, whereas plasma cholesterol in implanted cows was highest with rumen-escape (Megalac) lipid.

Other researchers have demonstrated ovarian responses to high-lipid diets. Lipid effects on pituitary response have been mixed, primarily as a consequence of differences in animal management or experimental design. Using a controlled system (ovariectomy with or without estradiol implants) showed that high-lipid, isocaloric diets enhance LH release in beef cows. This may help explain the positive influence of high-lipid diets on reproductive function.

Table 1. Effect of Lipid Source and Estradiol on Weight and Body Condition Change and Concentration of Estradiol in Mature, Ovariectomized, Beef Cows

Item	Nonimplanted ^a			E-implanted ^a			SE	Effect ^b	Contrast ^c	
	C	R	S	C	R	S			CvL	RvS
ΔWt, lb	+2	+35	+34	-7	+3	-12	14	E	.17	.56
ΔCondition score	+.2	+.1	+.1	+.0	+.3	+.2	.2	-	.57	.67
Estradiol, pg/ml	.4	.4	.5	13.9	14.3	18.4	2.6	E	.58	.46

^aC = control; R = rumen-escape lipid; S = soybean oil.

^bDenotes a significant ($P < .05$) effect of lipid (L), estradiol (E), or their interaction (LxE).

^cProbability value associated with the following orthogonal contrasts (CvL = control vs lipid; RvS = rumen-escape vs nonescape lipid).

Table 2. Effect of Lipid Source and Estradiol on Characteristics of Pulsatile Luteinizing Hormone Release in Mature, Ovariectomized, Beef Cows

Item ^a	Nonimplanted ^b			E-implanted ^b			SE	Effect ^c	Contrast ^d	
	C	R	S	C	R	S			CvL	RvS
Luteinizing hormone, ng/ml										
AMP	1.48	2.06	2.14	2.52	2.43	2.95	.18	L,E	.01	.09
MAX	5.03	5.39	5.62	6.09	6.25	6.52	.21	L,E	.04	.23
BASE	3.56	3.29	3.45	3.61	3.82	3.59	.33	-	.87	.90
FREQ	9.5	9.5	10.1	8.3	7.7	7.7	.5	E	.74	.54

^aAMP = peak amplitude; MAX = maximal pulse height; BASE = baseline excluding peaks; FREQ = pulse frequency.

^bC = control; R = rumen-escape lipid; S = soybean oil.

^cDenotes a significant ($P < .05$) effect of lipid (L), estradiol (E), or their interaction (LxE).

^dProbability value associated with the following orthogonal contrasts (CvL = control vs lipid; RvS = rumen-escape vs nonescape lipid).

Table 3. Effect of Lipid Source and Estradiol on Plasma Metabolites in Mature, Ovariectomized, Beef Cows

Item ^a	Nonimplanted ^b			E-implanted ^b			SE	Effect ^c	Contrast ^d	
	C	R	S	C	R	S			CvL	RvS
Plasma metabolites, mg/dl										
CHOL	140.7	161.7	228.9	147.7	233.5	161.0	6.3	L,L×E	.01	.68
TG	30.5	23.4	26.5	27.3	25.4	26.6	1.3	L	.01	.09
BUN	10.7	12.2	11.0	8.6	9.9	9.1	.6	L,E	.05	.08
GLU	65.5	61.6	63.2	65.1	63.7	65.6	.8	L,E	.01	.03
TP, g/dl ^e	8.12	7.87	8.08	8.06	7.91	8.22	.06	L	.19	.01

^aCHOL = cholesterol; TG = triglycerides; BUN = blood urea nitrogen; GLU = glucose.

^bC = control; R = rumen-escape lipid; S = soybean oil.

^cDenotes a significant ($P < .05$) effect of lipid (L), estradiol (E), or their interaction (L×E).

^dProbability value associated with the following orthogonal contrasts (CvL = control vs lipid; RvS = rumen-escape vs nonescape lipid).

^eTP = total protein.

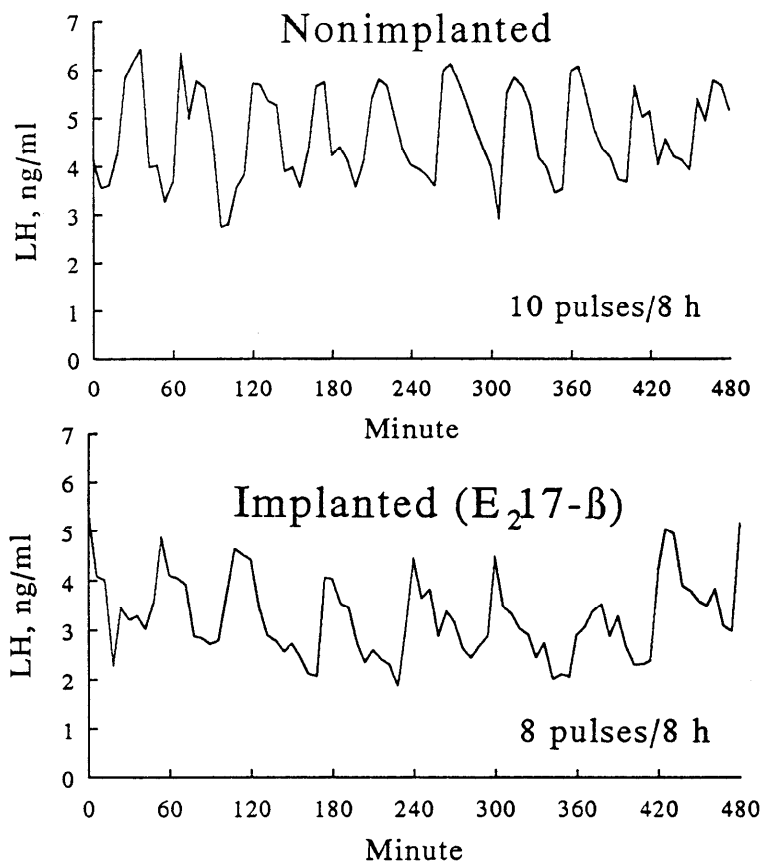

Figure 1. Profiles of Luteinizing Hormone Release in Ovariectomized Beef Cows Receiving Supplemental Estradiol or No Supplemental Estradiol

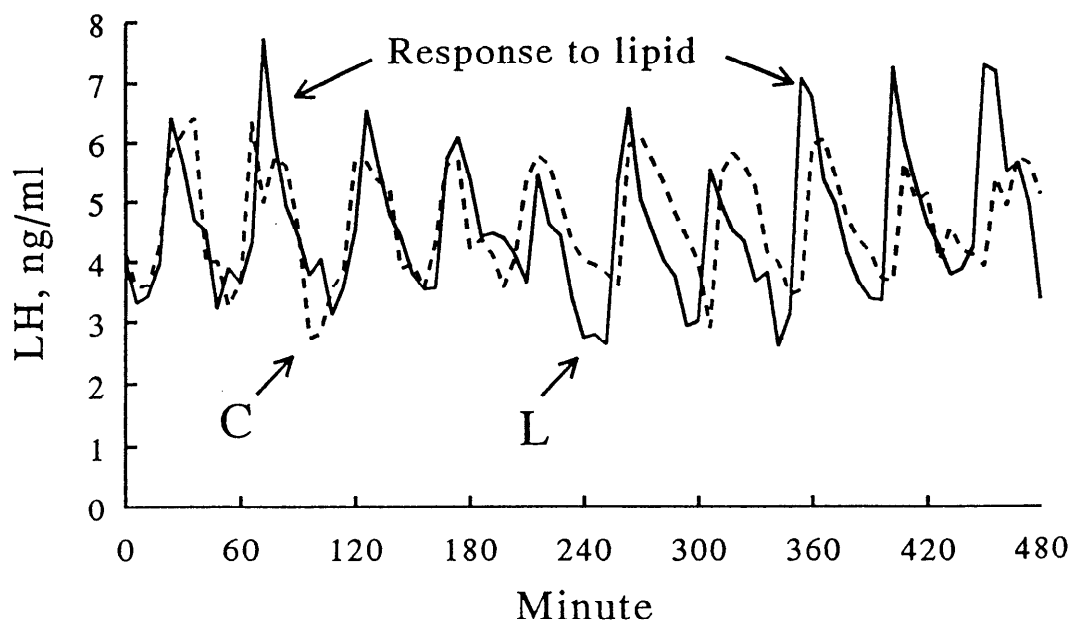

Figure 2. Profiles of Luteinizing Hormone Release in Beef Cows Fed Control (C) or Lipid (L) Supplements

EFFECT OF MOLYBDENUM/SULFUR-INDUCED COPPER DEFICIENCY UPON ENZYME LEVELS AND REPRODUCTION IN HEIFERS

J. D. Arthington and L. R. Corah

Summary

To evaluate the effects of molybdenum (Mo)- and sulfur (S)- induced copper (Cu) deficiency, 99 prepubertal heifers were allotted into two groups. Treated heifers (n = 72) were fed a grass hay naturally high in Mo (Mo = 8 ppm and Cu = 3.2 ppm). Sulfur was supplemented to achieve a dietary level of .3%. Control heifers (n = 27) received a grass hay with normal levels of Mo (Mo = .47 ppm and Cu = 1.5 ppm). Copper was supplemented to achieve a dietary level of 8 ppm. Diets were fed for a period of 163 d. Liver samples were collected and analyzed for total Cu. Copper-containing enzyme activity (ceruloplasmin and Cu,Zn-superoxide dismutase [Cu,Zn-SOD]), and progesterone were measured in blood serum. Heifers in the treated group had lower concentrations of liver Cu and decreased ceruloplasmin activity, with no differences noted in Cu,Zn-SOD activity or onset of puberty. No difference was detected in first-service conception rate following artificial insemination (AI). Overall AI pregnancy rate tended to be higher for control heifers.

(Key Words: Heifers, Copper, Ceruloplasmin, Cu,Zn-SOD, Reproduction.)

Introduction

Recently in Kansas, copper (Cu) was determined to be deficient in several beef cow herds. In many instances, forage Cu was adequate, but the deficiency appeared to be due to unusually high levels of sulfur (S) or molybdenum (Mo) or both. In the rumen, S and Mo combine to form a thiomolybdate complex. Thiomolybdates have the ability to

recombine with elemental Cu, forming an insoluble Cu-thiomolybdate complex. This complex renders Cu unavailable to the animal; therefore, causing a subsequent Cu deficiency.

The activity of two Cu-containing enzymes, ceruloplasmin and Cu,Zn-SOD, has been shown to be depressed in instances of Cu deficiency. Ceruloplasmin is the major carrier protein that delivers Cu to body cells. The enzyme Cu,Zn-SOD is the primary scavenger of toxic oxygen radicals that are produced during normal cellular respiration. By measuring the activity of these two enzymes, an estimate of the biological impact created by a Cu deficiency can be determined.

The experimental diet was formulated using native grass hay from a Kansas pasture with a history of high Mo content. Because no exogenous Mo was used, subsequent deficiency was thought to represent that occurring naturally in grazing beef herds under similar dietary conditions.

Experimental Procedures

Ninety-nine prepubertal heifers were allotted into treated (n = 72) and control (n = 27) groups. Heifers assigned to the treated group received a grass hay naturally high in Mo (Mo = 8 ppm and Cu = 3.2 ppm). Sulfur was supplemented to achieve a dietary level of .3%. Control heifers received grass hay with normal molybdenum levels (Mo = .47 ppm and Cu = 1.5 ppm). Copper was supplemented to achieve a dietary level of 8 ppm. Jugular blood and liver samples were collected on d 0, 41, 79, 110, 130, and 163 of the experiment. Liver samples were collected using a liver biopsy technique. Blood samples

were collected from the jugular vein. Liver Cu was analyzed utilizing inductively coupled plasma spectroscopy (ICP). Ceruloplasmin activity was determined by the *p*-phenylenediamine oxidase method. The enzyme Cu,Zn-SOD was determined by measuring the initial rate of inhibition of pyrogallol autoxidation. The number of heifers attaining puberty by the start of the breeding season (April 27) was determined by analysis of serum progesterone using a conventional radioimmunoassay technique. Estrus was synchronized in all heifers by feeding MGA for 17 d, followed by a single injection of prostaglandin F₂α. Heifers were inseminated artificially (AI) upon observation of standing estrus. The breeding season extended from April 27 until June 8.

Results and Discussion

Even though heifers in the treated group had lower ($P < .03$) liver Cu concentrations at the beginning of the study they experienced dramatic reductions in liver Cu by d 163 (Table 1). Ceruloplasmin levels were depressed ($P < .01$) in the treated group on d 130 and 163. No differences were detected in Cu,Zn-SOD activity.

No differences were detected in the percentage of heifers reaching puberty at the start of the breeding season (66.6% for both control and treated groups). Overall AI pregnancy rate tended to be higher ($P = .34$) for control (70.4%) than treated heifers (58.3%).

Molybdenum- and S-induced Cu deficiency decreased liver copper and serum ceruloplasmin, but had no effect upon serum Cu,Zn-SOD activity, attainment of puberty, and pregnancy rate.

Table 1. Copper and Enzyme Levels in Control (C) and Treated (T) Heifers

Trait		Day of experiment					
		0	41	79	110	130	163
Liver copper, ppm	C	148	238	111	72	68	115
	T	93 ^b	147 ^b	68	37	21 ^b	24 ^b
Ceruloplasmin, mg/100ml	C	13.9	14.1	11.6	12.0	16.5	15.2
	T	14.4	15.6	11.6	11.1	12.8 ^b	11.2 ^b
Cu,Zn-SOD, units ^a	C	.998	---	.785	---	---	.937
	T	.988	---	.800	---	---	.880

^a1 unit = 50% inhibition of initial rate.

^bDifferent ($P < .05$) from controls within day.

EFFECT OF DENSITY OF STEAM FLAKED MILO ON ANIMAL PERFORMANCE, MILL PRODUCTION RATE, AND SUBACUTE ACIDOSIS¹

*C. D. Reinhardt, R. T. Brandt, Jr.,
A. S. Freeman, T. P. Eck, and K. C. Behnke²*

Summary

In Trial 1, 336 yearling steers (755 lb) were fed diets containing milo flaked to 22 (L), 25 (M), or 28 (H) lb/bu. The steers fed L consumed 3.2% less dry matter than cattle fed H ($P < .05$) and had 6.9% lower gains ($P < .05$). Feed efficiency tended ($P = .15$) to favor cattle fed H. The H milo was flaked 27% faster than M and 67% faster than L ($P < .0001$), resulting in lower production cost for the heavy flakes. In Trial 2, six ruminally cannulated steers were fed the same diets used in Trial 1 in a replicated 3×3 Latin square. After adaptation to the respective diets, the cattle were fasted and then overfed to simulate a drastic intake fluctuation. The L diet was fermented more rapidly than the H diet, resulting in greater ruminal pH depression ($P < .10$) following overconsumption. Under the conditions of this experiment, flaking milo more intensively than 28 lb/bu (58.7% starch gelatinization) resulted in decreased consumption, lower mill efficiency, and increased propensity for acidosis in finishing steers.

(Key words: Steam Flaking, Milo, Density, Acidosis, Mill Efficiency.)

Introduction

Current information relative to steam flaking of milo suggests that conversion efficiency by beef cattle is optimized when the grain is flaked to 22 to 28 lb/bu. However, the

costs of producing various densities of flaked milo at near maximum mill load, has not been determined. Also unknown is the effect of flake density on subacute acidosis resulting from periods of intake fluctuation.

Experimental Procedures

Trial 1.

Three hundred thirty-six crossbred steers were received off wheat pasture in April, 1992. They were dewormed, vaccinated, ear-tagged, and stepped up to a medium-energy ration at a commercial feedyard in western Kansas. The cattle were then shipped to the Southwest Kansas Research-Extension Center in Garden City. The steers were stratified into four weight blocks and stepped up to the final ration containing milo flaked to 22, 25, or 28 lb/bu. Diets contained (DM basis) 82.5% flaked milo, 4% corn silage, 4% alfalfa hay, 7% supplement (43% CP, 8.7% urea), and 2.5% molasses. The cattle were weighed initially (May 25 and 26, 1992; avg 755 lb) and monthly until finished, at which time they were again weighed (September 27 and 28, 1992; avg 1139 lb) and slaughtered. Daily pen feed intakes were recorded.

The milo was sprayed with water and a wetting agent (Red-E-Flake®; Cargill, Inc., Molasses Div., Minneapolis, MN) and allowed to react for about 18 h prior to steaming. At startup each day, when the steam chest reached

¹The cooperation of Grant County Feeders, Ulysses, KS, who supplied the cattle used in Trial 1, is gratefully acknowledged.

²Department of Grain Science and Industry.

100°C the rolls (Ross 18×24 in. flaking mill, 25 hp) were warmed for 20 minutes by flaking grain to 25 lb/bu. After warmup, the rolls were tightened to flake the 22 lb/bu grain (L). When enough grain was processed for the light density treatment, the rolls were relaxed to flake the 25 lb/bu (M), and then the 28 lb/bu (H) grain. While flaking the grain for the test diets, mill load was maintained at 90% of maximum for all three densities. This resulted in average steam-chest retention times of 90, 70, and 50 minutes for L, M, and H respectively. The flaked milo averaged 79.5% DM beneath the rolls. Degree of starch gelatinization was determined on processed grain using differential scanning calorimetry.

Trial 2.

Six ruminally cannulated steers (avg 928 lb) were fed concurrently with the cattle in Trial 1. The steers were assigned in a replicated 3×3 Latin square arrangement to receive the same treatments as fed in Trial 1. We used a subacute acidosis challenge model in which cattle were acclimated to their respective treatment (intake restricted to 2% of BW per day, equal portions fed twice daily) for 9 days, and baseline rumen samples were taken on day 10. The p.m. feeding on day 11 was skipped, and then 1% of BW was provided in the a.m. on day 12. The cattle were allowed 90 min to consume the feed, at which time any unconsumed feed, plus ration equal to another 1.5% of BW was placed through the cannula into the rumen. Rumen samples were taken at feeding and at 3, 6, 9, 12, 18, and 24 h after. A second subacute acidosis challenge was conducted on day 13.

Results and Discussion

Cattle fed L consumed significantly less feed ($P < .05$) and gained more slowly ($P < .05$) throughout the trial than those offered H, with cattle fed M responding

intermediately (Table 1). Feed efficiency tended ($P = .15$) to favor those cattle fed H. These results conflict with previous reports of improved efficiency by cattle when offered extensively processed grain. No differences in carcass parameters were attributable to flake density.

At steady mill load (the situation in a commercial feedmill), grain was processed much more rapidly when flaked to H than M or L ($P < .0001$; Table 1). Increased pressure from the rolls resulted in a linear increase ($P < .05$) in starch gelatinization (Table 1). However, because electrical load was kept constant, mill throughput was decreased as flake density decreased. All costs associated with residence time and throughput (gas cost of maintaining chest temperature and electrical cost of running the mill) increased proportionately with decreasing production rate. Therefore, the L and M treatment flakes cost more per unit to produce than H.

In Trial 2, acidosis challenges with diet L reduced ruminal pH to a greater extent than those with diet H ($P < .10$; Figure 1). The lightweight grain was probably fermented more rapidly. However, there were no significant flake weight effects on ruminal concentration of either total VFA or lactate, which averaged 126.6 and 1.31 millimoles/liter, respectively. Data from Trial 2 suggest that finishing cattle fed highly processed milo are more susceptible to subacute acidosis resulting from irregular feed consumption patterns.

Under our conditions, flaking milo more extensively than 28 lb/bu (58.7% starch gelatinization) resulted in lower animal performance, lower mill efficiency, and increased animal susceptibility to subacute acidosis. Therefore, the proposed benefits from extensive steam-flaking of milo, except perhaps where light test-weight or highly variable milo is used, are suspect.

Table 1. Effect of Degree of Milo Flaking on Animal Performance, Mill Power Consumption, and Degree of Starch Gelatinization (Trial 1)

Item	Degree of flaking ^a		
	L	M	H
Performance data			
Number of pens	12	12	12
Number of steers	112	112	112
DMI, lb	18.4 ^b	18.8 ^{bc}	19.0 ^c
ADG, lb	2.99 ^b	3.09 ^{bc}	3.21 ^c
Feed/gain	6.13 ^d	6.10 ^{de}	5.92 ^e
Production data			
Rate, ton/h	1.155 ^f	1.521 ^g	1.929 ^h
Energy usage/ton			
Electricity, kwh	15.5	11.77	9.28
Natural gas, mcf	1.674	1.266	.997
Energy cost, \$/ton	3.79	2.87	2.26
Gelatinization, % ⁱ	85.7	74.3	58.7

^aL=22 lb/bu, M=25 lb/bu, H=28 lb/bu.

^{b,c}Means within a row without a common superscript differ (P < .05).

^{d,e}Means within a row without a common superscript differ (P = .15).

^{f,g,h}Means within a row without a common superscript differ (P < .0001).

ⁱLinear effect (P < .05).

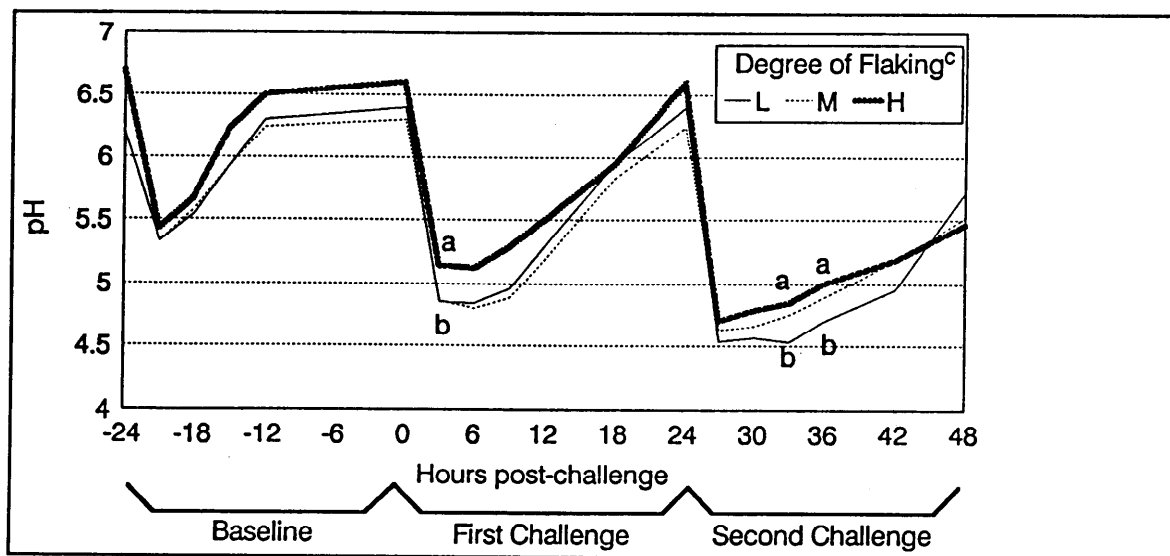

Figure 1. Effect of Degree of Flaking on Ruminal pH Changes Postchallenge (^{a,b} H differs from L (P < 10.) within a sampling time; ^c L=22 lb/bu, M=25 lb/bu, H=28 lb/bu)

EFFECT OF PHYSICAL FORM AND LEVEL OF ALFALFA IN CORN-BASED DIETS ON PERFORMANCE OF FINISHING STEERS¹

B. J. Healy, R. T. Brandt, Jr., and S. M. Gramlich

Summary

One hundred forty-four crossbred steers (850 lb) were used to evaluate the effects of physical form and level of average (15% CP) quality alfalfa on performance and carcass traits. Alfalfa hay had been harvested from a common field and alternate bales were either chopped (3 to 4 in. length) or ground and pelleted (3/8 in. pellet). No interactions between alfalfa form and level were detected. Daily gain, daily intake, feed efficiency, and carcass traits were similar for steers fed both alfalfa forms. Steers fed 10% alfalfa consumed 7.2% more feed ($P < .03$) than those fed 5%. Steers fed 5% alfalfa had marginally improved feed efficiencies, whereas those fed 10% had somewhat greater daily gains. Carcass traits were not affected by level of alfalfa. The incidence and severity of liver abscesses were greater ($P < .05$) for steers fed 5% alfalfa, indicative of a higher degree of acidosis than for steers fed 10% alfalfa.

(Key Words: Alfalfa, Hay, Pellets, Finishing Steers.)

Introduction

Previous research (1992 KSU Cattlemen's Day) suggested that high quality ($> 23\%$ CP) alfalfa provides more ruminal tactile stimulation when fed as chopped hay than as a dehydrated pellet. However, it is not known if average quality alfalfa, similar to that more typically used in feedlot diets, would produce a similar response. Further, the previous

study evaluated 1/4" pellets, whereas 3/8" pellets, which may provide greater bulk and(or) ruminal tactile stimulation, were used in the present study. Although it is obvious that pelleting adds to processing costs, pelleted alfalfa is cheaper to haul, less dusty, and less prone to wind losses. Our objective was to determine the effects of alfalfa form and level on performance and carcass traits of finishing steers fed corn-based diets.

Experimental Procedures

Alfalfa hay from a common field was harvested in July, 1992, sun-cured; and baled; alternate bales were either chopped (3 to 4 in. length) or ground and pelleted (3/8 in. pellet). The alfalfa was of average quality (15% CP). Both products were shipped to the Beef Research Unit, Manhattan. Chopped hay was stored in a covered hay shed, and pellets, in an overhead storage bin.

One hundred forty-four crossbred steers (850 lb), selected from a larger group of 387 based on uniformity in weight and breed type, were allocated to one of three weight blocks. Within each weight block, steers were allocated to one of four pens in a 2×2 factorially arranged experiment. Main effects were alfalfa form (chopped or pelleted) and level (5 or 10% of ration DM, Table 1). Steers had been processed using standard procedures and had been adapted to full feed prior to initiating the trial. Diets did not contain tylosin. Initial weights were the averages of two consecutive, early morning

¹The cooperation of National Farms, Inc., Kansas City MO, who supplied cattle used in this study, is gratefully acknowledged.

weights. Final weights were taken once because of inclement weather and poor lot conditions. Steers were slaughtered at a commercial plant, and carcass data obtained following a 24-h chill. The trial was conducted from August 6 - December 10, 1992.

Results and Discussion

No statistical interactions were detected between alfalfa form and level; thus, data were pooled across main effects. Steer performance and carcass traits were similar when comparing form of alfalfa fed, suggesting that ruminal bulk and(or) tactile stimulation were similar between chopped and pelleted alfalfa (Table 2). This contrasts with earlier KSU work that found slower gains and more indication of digestive upset when pellets were fed as compared to chopped hay. However,

the alfalfa used in the current study was lower in protein and likely had a lesser leaf:stem ratio, and pellet size was greater (3/8 in. vs 1/4 in.). Incidence and severity of liver abscesses tended to be greater for steers fed pelleted vs chopped alfalfa hay.

Steers fed 10% alfalfa consumed 7.2% more feed ($P < .03$) than those fed 5% alfalfa (Table 2). Daily gains were slightly greater for steers fed 10% alfalfa. However, steers fed 5% alfalfa were slightly more efficient (6.98 vs 7.21). Carcass traits were not different between steers fed 5 or 10% alfalfa, but severity of liver scores was markedly greater ($P < .05$) for steers fed 5% alfalfa. These results, combined with those from the earlier study, indicate that the maturity and/or pellet size of alfalfa influences ruminal bulk and(or) tactile stimulation.

Table 1. Diet Compositions^a

Ingredient	Chopped alfalfa		Pelleted alfalfa	
	5%	10%	5%	10%
Dry rolled corn	84.96	81.10	85.62	81.28
Chopped alfalfa	5.00	10.00	---	---
Pelleted alfalfa	---	---	5.00	10.00
Supplement ^b	7.54	6.54	6.88	6.22
Molasses	2.50	2.50	2.50	2.50

^aDM basis.

^bSupplements were formulated so that diets contained 12% CP, .7% Ca, .3% P, .7% K, 1550 IU Vit A, and 31 ppm monensin.

Table 2. Effect of Alfalfa Physical Form and Level on Performance and Carcass Traits of Steers

Item	Alfalfa form		Alfalfa level, % of DM		SEM
	Chopped	Pelleted	5%	10%	
No. pens	6	6	6	6	
No. steers	72	72	72	72	
Initial wt, lb	849	848	849	848	
Final wt, lb ^a	1188	1174	1176	1187	6.3
Daily gain, lb	3.11	3.00	3.01	3.11	.05
Daily feed, lb DM	22.0	21.3	20.9 ^d	22.4 ^e	.25
Feed/gain	7.07	7.11	6.98	7.21	.09
<u>Carcass traits</u>					
Hot wt, lb	760	751	751	760	4.4
Backfat, in	.43	.46	.43	.46	.01
KPH, %	2.28	2.28	2.29	2.28	.02
Marbling ^b	5.23	5.09	5.19	5.14	.66
Percent Choice	68.1	65.3	68.1	65.3	
Liver abscesses					
Incidence, %	40.0	48.5	55.1 ^d	33.3 ^e	
Severity ^c	1.0	1.3	1.4 ^d	.8 ^e	.09

^aPencil shrunk 4 %.

^b4 = slight, 5 = small, 6 = modest.

^cNormal = 0, severe = 3.

^{d,e}Means in a row with unlike superscripts differ ($P < .05$).

UTILIZATION OF DRIED BAKERY PRODUCT BY FINISHING BEEF STEERS

C. T. Milton and R. T. Brandt, Jr.

Summary

One hundred forty-four medium-framed crossbred steers averaging 857 lb were used to evaluate steer performance and determine net energy (NE) values of finishing diets that included dried bakery product (DBP). DBP replaced corn in the control diet at 15 or 30% of dietary DM. DM intake was depressed 6.5% by inclusion of 30% DBP. No differences in daily gain ($P > .3$) or feed efficiency ($P > .9$) were observed by replacing corn with DBP. Dietary values of NEm and NEg, calculated from animal performance, were not affected ($P > .7$) by the inclusion of DBP. Kidney, pelvic, and heart fat (KPH) ($P < .05$) and 12th rib fat thickness ($P < .1$) were increased linearly with inclusion of DBP, whereas other carcass characteristics were unaffected. These data indicate the DBP (10% rice hulls included) has an energy value similar to that of corn grain, although the optimal inclusion level of DBP appears to be below 30% of dietary DM.

(Key Words: Finishing Steers, Dried Bakery Product, Net Energy.)

Introduction

Dried bakery product is comprised of a variety of commodities such as hard and soft wheat products, pasta, potato chip waste, breakfast cereals, and other similar ingredients. Because it may be useful in finishing diets, our objectives were to evaluate effects of dietary level of DBP on animal performance and to determine its relative energy value.

Experimental Procedures

One hundred forty-four medium-framed, crossbred steers (857 lb), selected from a larger group of 387 based on breed type and weight, were stratified into one of four weight replicates. Within each replicate, steers were randomly allotted to one of three dietary treatments. The control diet was 80% rolled corn, 10% chopped alfalfa hay and 10% supplement and molasses. In the other diets, dried bakery product replaced corn at 15 or 30% of dietary DM. All diets were isonitrogenous (Table 1). The DBP in this study contained 9.5% CP, 10.9% EE, .28% Ca, and .32% P, with 10% rice hulls added for flowability. Initial steer weight was the average of two consecutive morning weights. A single final weight was used due to inclement weather conditions. Initial and final weights were shrunk 4% to approximate empty body weight for calculation of ADG, feed efficiency, dressing percentage, and NE values. Upon arrival, all steers were vaccinated against IBR, BVD, PI₃, and 7-way clostridia and were given an anthelmintic. Steers received Synovex-S® implants and were reimplanted on day 55 of the feeding period with Ralgro®. Following a 2-week step-up period, steers were fed experimental diets for 125 days. Liver scores and hot carcass weights were obtained at slaughter, and marbling score, KPH, and 12th rib fat thickness were obtained following a 24-hr chill. Dietary NEm and NEg values were calculated using NRC equations based on observed DM intake and ADG. NEm requirements were adjusted upward 14% (NRC, 1984) to account for wet, cold weather and muddy pens.

Results and Discussion

Results are shown in Table 2. DM intake of cattle consuming 30% DBP was depressed 6.5% vs control. There were no differences in daily gain ($P > .3$) or feed efficiency ($P > .9$) when DBP replaced corn. The increased fat (Table 1) from 30% DBP inclusion may have reduced intakes. We have observed that effect in other studies with 3 to 4% fat added to corn-based diets. Dietary concentrations of NEm and NEg were not different ($P > .7$) among treatments, suggesting that NEm and NEg concentrations of DBP were similar to those for corn. Replacing corn with DBP resulted in linear increases in KPH ($P < .05$) and 12th rib fat

thickness ($P < .10$). These results are similar to those from earlier studies on the addition of supplemental fat and suggest that DBP may alter carcass characteristics if used at high levels. Hot carcass weights, dressing percentage, and marbling scores were not affected ($P > .5$) by the inclusion of DBP. Cattle grading Choice (63%) were not affected by inclusion of DBP. The incidence of liver abscesses (38%) was not affected by treatment; no Tylosin® was included in diets. These results suggest that DBP and corn have similar NEm and NEg. Because of decreased feed consumption and increased carcass fatness, the optimal inclusion levels of DBP appears to be below 30% of dietary DM.

Table 1. Composition of Experimental Diets (DM Basis)

Diet	Control	15% DBP	30% DBP
Crude protein, %	12.0	12.0	11.9
Ether extract, %	2.7	3.9	5.1
Ca, %	.59	.59	.58
P, %	.30	.32	.34

Table 2. Effect of DBP Inclusion on Performance and Carcass Traits of Steers

Item	Control	15% DBP	30% DBP	SEM
No. pens	4	4	4	
No. steers	48	48	48	
Initial wt ^a , lb	823	823	822	1.13
Final wt ^a , lb	1215	1221	1194	12.23
ADG, lb	3.13	3.18	2.97	.09
DM intake ^b , lb	23.07	23.24	21.58	.56
Feed/gain	7.36	7.29	7.19	.01
HCW, lb	770	761	761	8.39
Dressing %	63.5	62.4	63.9	1.01
KPH ^c , %	2.25	2.38	2.43	.02
Fat 12th rib ^d , in.	.43	.48	.49	.02
Marbling score ^e	5.38	5.29	5.25	.17
Pct. Choice	63.8	66.7	58.7	
Liver abscesses, %	36.2	39.6	39.1	
NEm, Mcal/lb	.861	.864	.885	.02
NEg, Mcal/lb	.569	.571	.589	.02

^a4% pencil shrunk.

^bLinear trend $P < .11$.

^cLinear effect $P < .05$.

^dLinear effect $P < .10$.

^e4 = slight, 5 = small, 6 = modest.

EFFECT OF DIET ENERGY CONTENT AND LEVEL OF RESTRICTION ON PERFORMANCE, NUTRIENT DIGESTIBILITY, AND PUBERTY IN REPLACEMENT BEEF HEIFERS

R. V. Pope, R. T. Brandt, Jr., and J. S. Stevenson

Summary

Eighty Angus × Hereford crossbred weanling heifers (548 lb) were used in a 2 × 2 factorial experiment to evaluate dietary energy concentration (NEg .51 vs .61 Mcal/lb) and intake restriction (to produce 1.25 and 2.0 lb/d gain). Intake of the diets (corn - corn silage based; 14% CP) was adjusted every 2 weeks. Steer counterparts to the heifers were used in a 2 × 3 factorially arranged digestion experiment using the same treatments with an additional ad libitum intake level. There were no interactions between energy content and level of restriction. Heifers fed the higher energy diet maintained equal daily gain on 9.7% less ($P < .004$) feed, the probable result of higher ($P < .0001$) OM digestibility. Feed efficiency was improved 6.3% ($P = .14$) for heifers fed the higher energy diet. NRC (1984) energy equations underpredicted rate of gain of 1.25 and 2.0 lb/d by 24.6 and 7.7%, respectively, probably as a result of enhanced ($P < .05$) nutrient digestibility at the more restricted intake. Puberty (based on serum progesterone) was not influenced by treatment. Limitfeeding grain to produce replacement heifers appears practical when harvested forages are scarce and(or) high-priced.

(Key Words: Beef Heifers, Feed Restriction, Nutrient Digestibility, Performance.)

Introduction

The growing period of heifers between weaning and breeding has traditionally been based on high forage diets, but during dry years, forage supplies may be limited. Some producers have been interested in growing cattle on a higher energy, restricted intake diet

because grain is sometimes cheaper per unit of energy than harvested forages. The purpose of this experiment was to evaluate the effects of diet energy content and intake restriction on growth and cyclicity in replacement heifers.

Experimental Procedure

Eighty Angus × Hereford crossbred heifers (548 lb) from the same herd were used in a 2 × 2 factorial experiment. The main effects were dietary concentration of net energy for gain (NEg; .51 or .61 Mcal/lb) and level of feed restriction (calculated for rates of gain of 1.25 or 2.0 lb/day). Thus, heifers on the lower energy diet were fed (DM basis) 1.78 or 2.28% of body weight, and those on the higher energy diet were fed 1.62 or 2.05% of body weight daily. The heifers were allotted to four weight replicates and then to four pens within each replicate. The diets were corn - corn silage based and formulated to 14% crude protein. Diets containing .51 and .61 Mcal NEg/lb contained corn and corn silage in ratios of 1:3 and 3:1, respectively. Initial and final weights were taken after an overnight shrink. Blood samples were collected in the last 30 days of the trial at 10-day intervals. When serum progesterone exceeded 1 ng/ml, heifers were considered to have reached puberty.

Twenty-four steer counterparts to the heifers were used in a companion 2 × 3 factorial digestion experiment. The main effects were the same as for the heifer study with an additional ad libitum intake treatment. Steers were assigned randomly to the six treatments. An 18-day adaptation period was followed by a 7-day total fecal collection period. Digestibility of dry matter, organic matter, starch,

crude protein, neutral detergent fiber, and acid detergent fiber were measured. The heifer trial ran from November 1990 to March 1991, and the digestion trial, from February 20, to March 18, 1991.

Results and Discussion

Results are shown in Table 1. There were no interactions between energy content and level of intake. Heifers fed the higher energy diet maintained similar daily gain on 9.7% less ($P < .004$) feed. This is the probable result of the higher ($P < .0001$) organic matter digestibility of the higher energy diet. Feed efficiency was 6.3% better ($P = .14$) for heifers fed the higher energy diets. Heifers fed to gain 2.0 vs 1.25 lb/d consumed more DM ($P < .0001$) but were no more efficient.

NRC (1984) energy equations underpredicted rate of gain by 24.6 and 7.7% for heifers programmed to gain 1.25 and 2.0 lb/d, respectively. Enhanced ($P < .05$) organic matter digestibility on the more restricted diets may be partially responsible for this result. Treatment had no effect on the incidence of heifers reaching puberty. Heifers programmed to gain 1.25 and 2.0 lb/d were approximately 62 and 67% of mature weight, respectively, at the end of the trial. Daily feed costs were \$.18 lower for heifers restricted to 1.25 vs 2.00 lb/d. Although we were unable to follow reproductive performance on these heifers, minimizing total feed costs while maintaining adequate growth is probably more important for replacement heifers than rate or efficiency of gain. Limit-feeding grain to develop replacement heifers appears practical when traditional roughages are scarce and/or high-priced.

Table 1. Effect of Dietary Energy Concentration and Level of Feed Restriction on Performance and Puberty in Heifers and Nutrient Digestibility

Item	Diet NEg Mcal/lb			Predicted ADG, lb/d ^a			
	.51	.61	PR> F	1.25	2.0	Ad lib	PR> F
Heifer growth trial							
Initial wt., lb	546	550	.88	548	548	—	.95
Final wt., lb	746	744	.89	713	777	—	.016
Daily gain, lb	1.89	1.83	.30	1.56	2.16	—	.0001
DM intake, lb	13.16	11.88	.004	10.71	14.32	—	.0001
Gain/feed	.144	.153	.14	.146	.151	—	.42
Puberal ^b , %	47	52	.82	52	47	—	.66
Age ^c	351	351	.94	351	351	—	.89
Day cost, \$ ^d	.60	.62		.53	.71	—	
Steer digestion trial							
OM dig., %	70.3	79.0	.0001	76.9 ^e	73.2 ^f	73.4 ^f	—
Starch dig., %	87.2	92.3	.026	92.2	88.6	88.4	—
CP dig., %	68.2	72.1	.002	71.4	69.7	69.3	—
NDF dig., %	37.4	44.8	.023	45.6 ^e	37.2 ^f	40.4 ^{ef}	—
ADF dig., %	39.2	47.6	.022	47.1 ^e	38.8 ^f	44.3 ^{ef}	—

^aMean level of feed restriction (% of BW) to achieve the prescribed ADG was 1.78 and 2.28 vs 1.62 and 2.05% for the .51 vs .61 NEg treatments, respectively. Ad libitum consumption averaged 2.55% of BW.

^bHeifers attaining puberty by the final 30d of the trial.

^cAge of puberal heifers.

^dFeed only (\$2.50/bu corn; \$25/ton silage, \$190/ton supplement).

^{e,f}Means differ ($P < .05$).

EFFECT OF SUPPLEMENTAL FAT AND THERMAL STRESS ON NITROGEN AND ENERGY METABOLISM OF FINISHING HEIFERS

T. J. Jones, R. T. Brandt, Jr., and J. E. Williams¹

Summary

Twelve British and British crossed heifers fed whole shelled corn finishing diets were used in a 2×2 factorially arranged experiment to study the main effects of and interactions between feeding supplemental tallow (0 vs 4%) and thermal heat stress (55°F vs 90°F). Heifers were maintained in temperature- and humidity-controlled environmental rooms. Neither supplemental fat or thermal stress affected dry matter intake or total tract digestibility of organic matter, starch, NDF, or ADF. However, heat stress elevated water consumption ($P < .01$) and rectal temperature ($P < .01$). When fed at equal intakes, heifers consuming tallow-supplemented diets retained more ($P < .05$) nitrogen, and tallow-supplemented diets had a higher ($P = .08$) ME value than non-tallow diets; these effects were not observed when heifers were fed ad libitum. Adding tallow to diets of finishing cattle may help maintain performance under circumstances where feed intake is restricted.

(Key Words: Beef Heifers, Metabolism, Tallow, Thermal Stress.)

Introduction

Cattle tend to reduce feed intake in hot weather as a means of controlling their rising body temperature. Because fat has a lower heat increment than carbohydrates or proteins, fat supplementation should theoretically reduce the heat of digestion and fermentation, thereby lowering the animal's heat load under thermal stress. Therefore, the purpose of this

experiment was to determine the effects of heat stress and supplemental fat on nitrogen retention and on the energy density and nutrient digestibility of a corn-based finishing diet consumed by heifers.

Experimental Procedures

Twelve British and British crossed heifers (avg. wt. 650 lbs) were randomly allotted to one of four treatments: 55°F & 0% tallow, 55°F & 4% tallow, 90°F & 0% tallow, and 90°F & 4% tallow. They were maintained in environmental chambers with 50% relative humidity and 24-hour lighting. The thermo-neutral room was 55°F 24 hrs/day, whereas the heat stress room cycled from 74°F to 90°F over 24 hours: 74°F from 2 a.m. to 6 a.m. and 90°F from 2 p.m. to 6 p.m. with 2°F/hr changes between these plateaus.

We used two 30-day periods, each consisting of a 10-day dietary fat adaption period, a 7-day temperature adaption period, a 5-day ad libitum collection period, a 3-day equalized intake adaptation period, and a 5-day equal intake period. The diets were based on whole shelled corn and contained 10% orchardgrass hay. We collected total urine and feces and determined digestibility of organic matter, starch, NDF, ADF, and fat. Digestible energy was calculated by subtracting fecal energy from feed energy. Metabolizable energy (ME) was derived by subtracting both urinary energy and estimated methane losses from the digestible energy. Diet net energy values were calculated from ME (NRC, 1984).

¹Professor of Animal Science, University of Missouri, Columbia.

Results and Discussion

Dry matter intake as a percent of body weight was similar among treatments (Table 1). However, heat stress increased ($P = .001$) rectal temperature and water consumption ($P = .001$). The total tract digestibility of starch, NDF, ADF, and organic matter were not affected by tallow or temperature level. Conversely, tallow supplementation increased ($P = .05$) nitrogen digestibility when heifers were limit fed, but not when they were fed ad libitum. In addition, when heifers were limit fed, supplemental tallow increased ($P < .05$) nitrogen retention, whereas heat stress decreased ($P = .06$) nitrogen retention; those trends were not observed with heifers fed ad libitum.

Supplemental tallow increased ($P = .08$) ration digestible energy, metabolizable energy, and net energy for both maintenance and gain when diets were fed at equalized intakes. However, these responses were not significant when heifers were fed ad libitum. Further, total tract fat digestion was depressed ($P = .08$) by elevated environmental temperature and was increased ($P < .05$) by addition of 4% tallow for ad libitum fed heifers. Neither fat nor temperature had any effect on fat digestion in limit-fed heifers. In conclusion, tallow enhanced energy utilization and nitrogen retention at equal (restricted), but not at ad libitum, intakes. With restricted intake, tallow may reduce heat production and lower maintenance energy expenditures. Tallow may help cattle performance under circumstances where consumption is restricted.

Table 1. Effect of Level of Fat and Environmental Temperature on Intake, Digestion, and Metabolism

Item	55 °F		90 °F		Probability		
	0%	4%	0%	4%	TEMP	FAT	T × F
	tallow	tallow	tallow	tallow			
AD LIBITUM PHASE							
DM intake, % BW	2.79	2.96	2.95	2.64	.67	.71	.26
Water intake, l	13.0	15.4	25.7	25.9	.03	.48	.21
Rectal Temp,	101.7	101.6	103.4	103.6	.001	.75	.43
Digestibility, %							
OM	75.0	73.7	73.7	74.4	.88	.88	.64
Starch	97.5	96.6	96.1	96.5	.24	.64	.33
Fat	66.7	72.3	57.6	68.4	.08	.03	.46
Nitrogen	69.1	68.9	67.7	71.0	.88	.54	.47
ADF	50.6	40.9	47.7	42.6	.90	.15	.64
NDF	53.6	51.4	56.4	56.1	.38	.77	.82
DE, Mcal/lb	1.43	1.46	1.40	1.46	.64	.18	.63
ME, Mcal/lb	1.28	1.33	1.26	1.31	.62	.18	.97
NEm, Mcal/lb	.85	.90	.83	.88	.59	.17	.97
NEg, Mcal/lb	.56	.60	.55	.59	.62	.18	.95
N retention, g/d	64.6	67.1	59.1	58.8	.42	.89	.87
EQUAL INTAKE PHASE							
DM intake, % BW	2.13	2.11	2.13	2.11	.78	.001	.78
Water intake, l	15.3	12.9	19.4	27.4	.03	.48	.21
Rectal Temp, F	101.6	101.6	102.4	102.5	.001	.62	.55
Digestibility, %							
OM	75.7	76.6	74.9	74.6	.53	.89	.78
Starch	96.8	96.8	97.2	97.2	.41	.95	.95
Fat	73.2	82.1	75.2	73.2	.11	.11	.02
Nitrogen	64.8	70.4	64.2	69.2	.73	.05	.89
ADF	45.4	51.3	45.9	44.5	.55	.66	.48
NDF	53.5	55.4	51.6	53.2	.66	.72	.97
DE, Mcal/lb	1.40	1.51	1.39	1.45	.45	.06	.62
ME, Mcal/lb	1.24	1.35	1.23	1.29	.41	.08	.58
NEm, Mcal/lb	.82	.91	.81	.86	.41	.08	.57
NEg, Mcal/lb	.54	.62	.53	.57	.41	.08	.55
N retention, g/d	20.9	37.0	16.3	23.0	.05	.02	.32

PROTEIN SUPPLEMENTATION OF AMMONIATED WHEAT STRAW: EFFECT ON INTAKE AND DIGESTION IN BEEF STEERS¹

*G. D. Fike, D. D. Simms, R. C. Cochran,
R. T. Brandt, Jr., E. S. Vanzant, and G. L. Kuhl*

Summary

Sixteen ruminally fistulated steers (avg wt. = 998 lb) were used in a 30-day conventional digestion trial to examine the effects of protein supplementation on intake and digestion of ammoniated wheat straw. Steers were assigned to one of four protein supplementation programs: 1) Control (C) - no supplement, 2) Low Protein (LP) - 4.5 lb of a 10% crude protein (CP) supplement, 3) Medium Protein (MP) - 4.5 lb of a 20% CP supplement, or 4) High Protein (HP) - 4.5 lb of a 30% CP supplement. Supplements were mixtures of milo and soybean meal. Supplementation increased ($P < .05$) dry matter intake, tended ($P = .09$) to increase intake of digestible neutral detergent fiber (NDF), and increased ($P < .05$) intake of forage dry matter. Dry matter digestibility was higher ($P < .05$) for HP steers than C and LP steers, but no difference was detected between MP, and HP steers. Steers on HP, MP, and C treatments exhibited higher NDF digestibility than LP steers. Rumen pH, total volatile fatty acid concentration, and acetate to propionate ratio were unaffected by supplementation.

(Key Words: Ammoniation, Intake, Digestibility, Supplementation, Wheat Straw.)

Introduction

Wheat straw is abundant in Kansas but is of limited value because of its low digestibility. Ammoniation has been shown to increase its

digestibility, intake, and crude protein content. Prior research has shown that natural protein is the major limiting nutrient in the utilization of ammoniated wheat straw by beef cows. This study was conducted to determine the effect of increasing levels of supplemental natural protein on intake, digestion, and rumen fermentation characteristics of cattle fed ammoniated wheat straw.

Experimental Procedures

Sixteen ruminally fistulated steers were randomly allotted by weight to a control treatment (no supplement) or 4.5 lb per day of a supplement formulated to contain 10, 20, or 30% crude protein. The straw was tub ground to pass through a 3-inch screen and fed ad libitum. The steers were fed in an open-fronted barn in individual pens. Feed offered and refused was measured daily to obtain intake; during the final 7 days steers were fitted with fecal bags for a total collection to measure digestibility. On day 29, rumen contents were manually removed, sampled, and immediately returned to the rumen at feeding and 4 hours postfeeding. On day 30, rumen fluid was collected at feeding and at 3, 6, 9, and 12 hours postfeeding to measure volatile fatty acid concentrations, pH, and a soluble marker, which was used to measure liquid dilution rate.

¹The authors gratefully acknowledge the assistance of Gary Ritter and Wayne Adolph; graduate students John Arthington, Sandra Utter, Todd Milton, Barb Lintzenich, Jane Beatty, and Chris Reinhardt; undergraduates L.J. Wasinger, Kelly Griffin, and Ellen Johncock during this trial.

Results and Discussion

After ammoniation, CP content of the straw averaged 10.5%. Actual CP contents of the supplements were: LP = 12.0%; MP = 21.7%; and HP = 31.7%. Forage dry matter (DM) intake and total DM intake were increased ($P < .01$) by supplementation, with a significant ($P < .01$) linear response to increasing levels of crude protein. Dry matter digestibility was increased by supplementation with 30% protein. NDF digestibility was depressed by feeding the LP supplement. Dry matter ruminal fill at 4 hours postfeeding (data not shown) was greater

($P < .05$) for supplemented steers than for controls, reflecting the increase in DM intake. Rumen pH, total volatile fatty acid concentrations, and acetate to propionate ratio were unaffected by supplementation.

This study helps explain the results of the associated cow feeding trial (see page xxx), in which cows fed the higher protein level gained slightly more than those on the LP treatment. The higher forage intake and higher NDF digestibility for the MP and HP treatments compared to the LP treatment resulted in greater intake of digestible energy.

Table 1. Intake, Digestibility and Fermentation Characteristics of Steers Consuming Ammoniated Wheat Straw and Supplements Varying in Protein Content

Item	Treatment			
	C	LP	MP	HP
Forage DM Intake ^d	1.56 ^a	1.77 ^a	1.92 ^{ab}	2.24 ^b
Total DM Intake ^d	1.61 ^a	2.19 ^b	2.34 ^b	2.67 ^b
DM Digest., %	52.9 ^{ab}	51.7 ^a	58.9 ^{bc}	60.2 ^c
NDF Digest., %	70.2 ^a	63.5 ^b	68.7 ^a	70.4 ^a
Rumen pH	6.17	6.31	6.13	6.33
VFA concentration ^e	103.6	96.5	100.1	107.1
Acetate:Propionate molar ratio	3.51	3.68	3.37	3.40

^{abc}Means within a row with unlike superscripts differ ($P < .05$).

^dIntake expressed as a % of body weight.

^eVolatile fatty acid concentration expressed as millimoles per liter.

PROTEIN SUPPLEMENTATION OF AMMONIATED WHEAT STRAW: EFFECT ON PERFORMANCE OF BEEF COWS¹

*G. D. Fike, D. D. Simms, R. T. Brandt, Jr.
R. C. Cochran, E. S. Vanzant, and G. L. Kuhl*

Summary

Mature, crossbred beef cows (n = 87 in 1990-91, n = 84 in 1991-1992) were used to determine the effects of protein supplementation to cows fed ammoniated wheat straw during late gestation. Treatments included: 1) Control (C) - no supplement, 2) Low Protein (LP) - 4.5 lb of a 10% crude protein (CP) supplement, 3) Medium Protein (MP) - 4.5 lb of a 20% CP supplement, and 4) High Protein (HP) - 4.5 lb of a 30% CP supplement. Supplementation increased weight gain over controls (P < .01). HP cows gained more (P = .05) weight than LP-supplemented cows and tended (P = .11) to gain more weight than MP-supplemented cows. Supplementation also increased body condition score (BCS, 1-9 scale) over control cows (P < .01), but no difference was noted among supplemented groups. From the end of the feeding period until weaning, cows previously supplemented lost more weight (P < .01) than controls and exhibited little change in BCS, whereas controls increased BCS by .5 during the same period. Calving dates, calf birth weights, calf weaning weights, calf average daily gain, percent of cows cycling prior to breeding, and percent of cows pregnant did not differ between treatments. Consequently, although additional protein increased weight gain prior to parturition, this response did not impact economically important traits.

(Key Words: Ammoniation, Wheat Straw, Protein Supplementation, Beef Cows.)

Introduction

Wheat straw is abundant in Kansas and has significant usefulness in the rations of dry, gestating cows. Ammoniation of wheat straw usually doubles the nitrogen content and greatly increases fiber digestibility by breaking bonds between hemicellulose and lignin. Prior research at Kansas State University has shown that even though ammoniated wheat straw has adequate CP for a cow in late gestation (10.5% CP versus requirement of 7.8% CP), additional natural protein may be needed because energy is inadequate for the rumen microorganisms to utilize the high level of nonprotein nitrogen. Our purpose was to examine the effects of increasing levels of protein supplementation on the performance of beef cows fed ammoniated wheat straw during late gestation and on their subsequent performance.

Experimental Procedure

Large round bales of wheat straw were stacked in a 3-2-1 pyramid, covered with 6 mil black plastic, sealed at the base with sand, and treated with anhydrous ammonia at the rate of 60 lb per ton (3%, wt/wt) of forage in late summers of 1990 and 1991. The straw was ground to pass through a 3-inch screen in a conventional tub grinder and fed ad libitum to beef cows in the last trimester of pregnancy.

Cows (n = 87 in 1990-91; n = 84 in 1991-92) were randomized by weight, body condition score, age, and breed type and

¹The authors gratefully acknowledge Gary Ritter and Wayne Adolph; graduate students John Arthington, Sandra Utter, Mitch Smith, and Clyde Cranwell; and undergraduates L.J. Wasinger and Kelly Griffin for their help in collection of the data.

assigned to one of four protein supplementation treatments (Table 1).

Cows were weighed and condition scored on two consecutive days after an overnight shrink, at the beginning and end of the feeding period. There were three pens per treatment each year. The feeding periods lasted 84 days in 1990-91 and 60 days in 1991-92 and ended just prior to initiation of calving.

During and after calving, the cows were maintained as one group on native bluestem range and supplemented with 10 lb per head per day of alfalfa hay. Calves were weighed and identified at birth. Two blood samples were drawn from the cows at 10-day intervals in year 1 just prior to the breeding season and assayed for progesterone to determine cyclicity. Calves were weighed and vaccinated, and bull calves were castrated and implanted prior to the grazing season. The cows and calves grazed native bluestem pasture until weaning. Cows were exposed to bulls during the first 60 days of the grazing season.

Results and Discussion

Supplementation of ammoniated wheat straw increased cow weight gain during the

feeding period ($P < .001$; Table 2). Cows fed HP gained more ($P < .05$) than LP cows, but there were no significant differences in weight gain between MP and other supplements. Body condition score was also increased by supplementation ($P < .01$), with no differences noted among supplemented groups. Cows on the control diet compensated in weight and condition score changes prior to weaning in the fall. For example, control cows lost 33 lb from the end of the feeding period to weaning, whereas LP-, MP-, and HP-supplemented cows lost an average of 94 lb. Additionally, control cows gained approximately .5 BCS during the same period, whereas supplemented cows showed little change. No differences were noted between treatments in calving dates, calf birth weights, calf weaning weights, calf average daily gain, percent of cows cycling at the beginning of the breeding season, or pregnancy rates.

Although supplementing cows fed ammoniated wheat straw tended to increase weight gain and body condition in late gestation, nonsupplemented cows compensated during the subsequent grazing season, thereby eliminating any economical benefits of supplementation. Based on these results and previous research, protein supplementation to cows fed ammoniated wheat straw may be cost effective only when the weather is severe.

Table 1. Treatments Used in the Evaluation of Protein Supplementation of Beef Cows Fed Ammoniated Wheat Straw in Late Gestation.

Treatment	% Crude protein	Sorghum grain, lb	Soybean meal, lb
Control	--	--	--
Low Protein (LP)	12.0	4.5	--
Medium Protein (MP)	20.1	3.32	1.18
High Protein (HP)	31.7	2.12	2.37

All treatments received .5 lb of mineral supplement formulated to meet the mineral requirements of a beef cow in late gestation.

Table 2. Effects of Protein Supplementation on the Performance of Beef Cows Consuming Ammoniated Wheat Straw

Item	Treatment				SEM
	C	LP	MP	HP	
<u>During Feeding Period^x</u>					
Wt. gain, lb	72 ^a	134 ^b	138 ^{bc}	159 ^c	9.8
Change in body condition ^d	-.47 ^a	0 ^b	.11 ^b	.09 ^b	.09
<u>From End of Feeding Period to Weaning</u>					
Wt. change, lb	-33 ^a	-95 ^b	-96 ^b	-96 ^b	13.1
Change in body condition ^d	.51 ^a	-.10 ^b	-.04 ^b	-.04 ^b	.11
Calf birth wt., lb	86	86	86	87	2.2
Calf ADG, lb	2.14	2.08	2.05	2.10	.03
Calf weaning wt., lb	550	539	533	548	9.5
Cycling at start of breeding ^e	61	86	76	81	
Pregnant ^f , %	95	94	92	100	

^{a,b,c}Means within rows with different superscripts differ ($P < .05$).

^dBody condition score 1-9 (1 = extremely emaciated, 9 = extremely obese).

^eData from 1990-91 only.

^fDetermined via calving for 90-91, via rectal palpation at weaning in 91-92.

SEM = Standard Error of the Mean.

^x84 days in 1990-1991, 60 days in 1991-1992.

GASTROINTESTINAL THIAMINASE VS. RATION CHANGES

H. W. Soita and B. E. Brent

Summary

High levels of the thiamin-destroying enzyme, thiaminase I, were found in the feces of 3 of 50 apparently healthy dairy cows. All high fecal thiaminase I levels returned to normal within 3 weeks, indicating that thiaminase I occurs in "spikes" rather than continuing at elevated levels. All cows sampled had some thiaminase I, but the upper end of the "normal" range in feces was about 3.5 $\mu\text{mol}/\text{min}/\text{l}$. Thiaminase I levels were higher in the first than in subsequent lactations. When spikes in thiaminase I activity occurred, they were concentrated within about 20 days of calving and of the associated change to a high concentrate diet. Lactating cows fed a high concentrate post-calving diet had more thiaminase I than parturient cows fed a lower energy diet.

(Key Words: Polioencephalomalacia, Thiamin, Thiaminase.)

Introduction

Polioencephalomalacia is a central nervous disorder in ruminants. Affected animals respond rapidly to large thiamin injections even though thiamin intake and ruminal thiamin synthesis should be more than adequate. Although other factors are involved, the main cause appears to be microbial synthesis in the gastrointestinal tract of an enzyme that destroys thiamin. That enzyme, designated thiaminase I, splits the thiamin molecule between its two rings and substitutes a nitrogen-containing base (cosubstrate) for thiazole. Thus, for thiamin to be destroyed, three factors must be present; thiaminase I, thiamin (the primary substrate), and the cosubstrate. British researchers have shown that fecal thiaminase can serve as a

marker for the presence of thiaminase in the gastrointestinal tract and also that high levels of fecal thiaminase may be present in apparently healthy animals. Little is known as to whether or not those high levels persist. Hayes and Brent (KSU Cattlemen's Day, 1989) found a high level of fecal thiaminase I in a substantial number of feedlot cattle and suggested that polioencephalomalacia failed to develop because the appropriate co-enzyme was not present.

Several researchers have suggested that high levels of thiaminase I develop in response to ration changes. Dairy cattle offer a unique opportunity to study thiaminase because they are switched from a high roughage diet to a high energy diet at each calving.

Experimental Procedures

In our first experiment, fecal thiaminase was measured in 50 dairy cows that were from 8 to 139 days in milk. Three cows were found with fecal thiaminase levels above 3.5 $\mu\text{mol}/\text{min}/\text{l}$. Those cows were resampled weekly for 4 weeks. At the end of 4 weeks, all cows were re-sampled.

In a second experiment, five dairy cows were selected at random and sampled while on their precalving diet (roughage plus 14 lb/hd/day of concentrate) for 3 weeks prior to calving. At calving, the cows were switched to roughage plus 32 lb/hd/day of concentrate and were sampled weekly for an additional 3 weeks.

Fecal samples were diluted 1:1 with distilled water, and strained through cheesecloth,

and the resulting solution was assayed for thiaminase I. Each assay included a small amount of radioactive thiamin (labeled in carbon 1 of the thiazole ring), excess nonradioactive thiamin, and aniline as a cosubstrate. As radioactive thiamin was decomposed, its radioactivity was extracted into ethyl acetate. Activity was expressed as micromols of thiaminase destroyed per minute per liter of fresh feces ($\mu\text{mol}/\text{min}/\text{l}$). All samples that showed high levels of thiaminase were reassayed without aniline to confirm that the thiamin was being decomposed by thiaminase I and not by simple chemical activity.

Results and Discussion

Thiaminase I has been present in the feces of all cattle feces we have assayed. However, the levels are normally low. We defined the upper limit of normal thiaminase I activity as the point at which samples exceeded the cumulative average plus two standard deviations. That technique estimated $3.5 \mu\text{mol}/\text{min}/\text{l}$ as the upper normal thiaminase level.

In the first experiment, three animals were found with thiaminase I levels greater than $3.5 \mu\text{mol}/\text{min}/\text{l}$. When reassayed at weekly intervals, all had returned to normal levels before the third weekly sample (Figure 1). That strongly suggests that when an animal has a high level of gastrointestinal thiaminase, the problem persists for a relatively short time. This may help explain why very few animals develop polioencephalomalacia, even though thiaminase I is high. When the entire group of 50 cows was reassayed 4 weeks after the initial assay, no abnormally high thiaminase I levels were found.

When the dairy cows calved, their concentrate intake was increased from 14 to 32 lb/hd/day. Figure 2 shows the relationship between thiaminase levels and days after the concentrate increase. The three highest thiaminase values were within 20 days after calving. We have previously observed that polioencephalomalacia is most likely about 3 weeks after a ration change. Our data suggest that thiaminase production in the gastrointestinal tract may coincide with adaptation to a new diet.

Figure 3 shows the relationship between thiaminase I activity and lactation number. Thiaminase levels were higher ($P < .05$) during the first lactation than subsequent lactations. Cows in the first lactation are experiencing their first substantial ration change. Behavioral and/or physiological differences between the first and subsequent calvings may account for differences in thiaminase levels.

Results of the second experiment are shown in Figure 4. Mean thiaminase I activity was lower ($P < .05$) on the precalving diet (14 lb/hd/day concentrate) than on the postcalving diet (32 lb/hd/day concentrate). The highest thiaminase I level in this experiment was $4.1 \mu\text{mol}/\text{min}/\text{l}$. The absence of thiaminase I spikes like those seen in the first experiment is not surprising because we were sampling only 5 cows, and high thiaminase levels were observed in only 3 cows out of 50 in the first experiment.

The effect of thiaminase spikes on animal performance is unknown and will be difficult to measure. Few animals are affected, and the performance depression, if it occurs, is probably transitory. Thiaminase I in feces may not mean that the thiamin status of the animal is severely compromised, because a cosubstrate must be present for thiamin to be destroyed. However, the presence of fecal thiaminase I casts doubt on the presumption that thiamin is always adequate in ruminants.

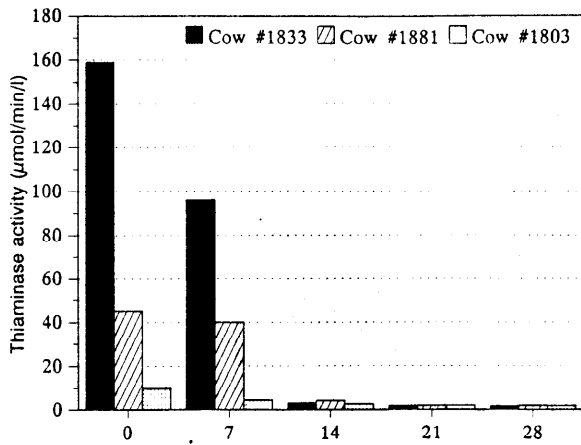

Figure 1. Decline of Fecal Thiaminase with Time in Three Dairy Cows Initially Found to Have Abnormally High Fecal Thiaminase

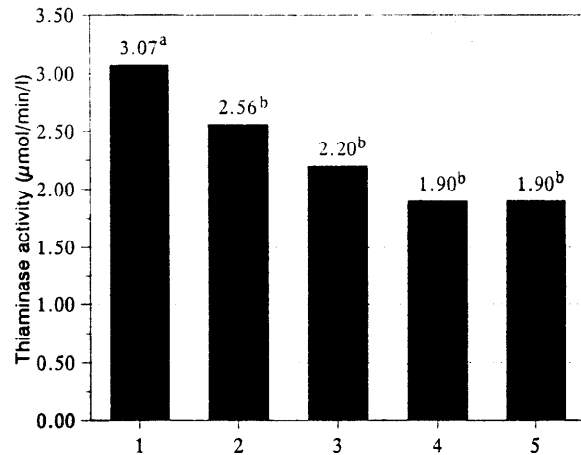

Figure 3. Effect of Lactation Number on Thiaminase Activity

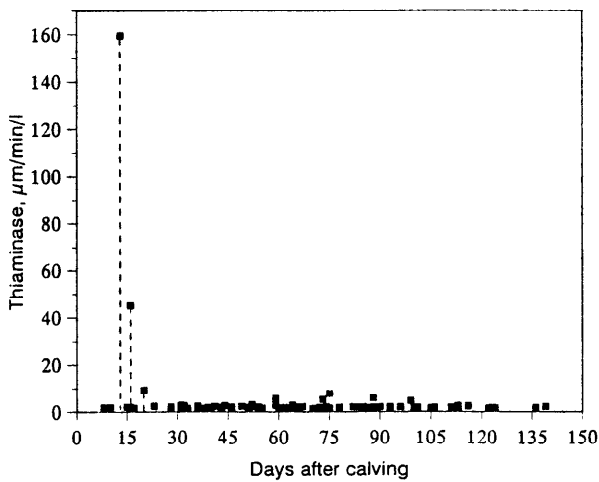

Figure 2. Fecal Thiaminase Levels vs. Time after Calving

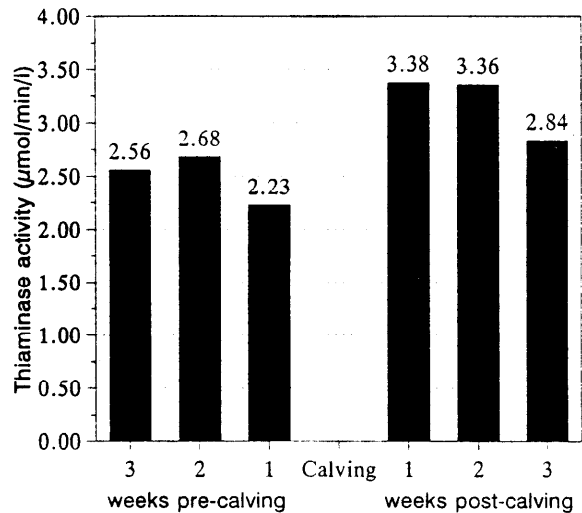

Figure 4. Effect of Increasing Concentrate at Calving on Fecal Thiaminase

FACTORS AFFECTING CATTLE FINISHING PROFITABILITY

*J. R. Mintert¹, T. C. Schroeder¹, M. R. Langemeier¹,
and M. L. Albright¹*

Summary

The relative contributions of fluctuating cattle performance; interest rates; and feeder cattle, fed cattle, and feed grain prices to profit variability of cattle feeding were examined in this study. Closeout data from 6696 pens of steers placed on feed between January 1980 and May 1991 at two western Kansas custom feedyards were used to estimate the relative impacts of prices and animal performance on cattle feeding profits. Combined, fed and feeder cattle prices explained 70 to 80% of profit variability, depending on placement weight. Overall, cattle prices and feeding costs explained at least 85% of the variation in profitability. Animal performance explained 5 to 10% of profit variability.

(Key Words: Cattle Finishing Profitability, Sale Prices, Feeder Cattle Prices, Placement Weight, Animal Performance.)

Introduction

This study examined the relative contributions of cattle performance; interest rates; and fed, feeder cattle and corn prices to profit variability of cattle feeding. The potential impact of changing prices and cattle performance on profitability should be considered as cattle producers develop budget projections and contemplate placing cattle on feed. Improvements provided by this analysis relative to previous research include the use of pen-level data instead of monthly

averages, separate profitability analysis for each of three different placement weight categories, and a closeout data set more than twice the size of that used previously.

Experimental Procedures

Analysis was conducted using closeout data on 6696 pens of steers placed on feed in two western Kansas custom feedyards between January 1980 and May 1991. Information collected from the closeouts included placement date, feeder cattle purchase price, placement weight, days on feed, total gain, daily gain, sale weight, feed conversion (as-fed), yardage charges, feed cost, feed consumption (as-fed), feeding cost per pound of gain, fed cattle sale price, and slaughter date. Average monthly southwestern Kansas corn prices were obtained from Kansas Agricultural Statistics. Interest rates on feeder cattle loans were obtained from the Kansas City Federal Reserve Bank. Only pens of steers placed on feed weighing between 600 and 899 lb were used in this analysis. All prices, returns, and costs were adjusted for inflation by expressing them in January 1991 constant dollars.

Net returns were estimated as a function of fed cattle price, feeder cattle purchase price, corn price, feed conversion, daily gain and feeder cattle interest rate in a regression equation. Estimates from the regression equation were used to calculate coefficients of separate determination that allocate the total variability explained by these factors

¹Department of Agricultural Economics.

as a group into their individual explanatory contributions to net return risk. The model used did not include seasonal factors.

Results and Discussion

Figure 1 illustrates the estimated, monthly, average, real, net returns to finishing 700 to 799 lb feeder steers over the 1980 through May 1991 placement period. Real (adjusted to 1991 dollars) profits averaged \$43.30 to \$49.36/head, and nominal profits (unadjusted for inflation) averaged \$25.38 to \$27.28/head, depending on placement weight. Feed conversion (as-fed) increased from 8.24 for lighter weight placements to 8.57 for heavier placements, reflecting reduced feed efficiency of heavier cattle. Average daily gain was also greater for heavier compared to lighter weight placements (3.25 vs 3.06 lb). Nominal cost of gain averaged from \$48 to \$50/cwt, depending on placement weight.

Table 1 presents the relative contributions of fed, feeder, and corn prices; interest rates; feed conversion; and daily gain to the variability in steer profits. Fed cattle price was the most important explanatory factor for lighter weight placed steers, explaining more than 50% of the profit variance and was the second most important factor for the 800 to 899 lb placement category, explaining 38% of profit variation. Feeder cattle purchase price was the most important variable for heavy weight placements, explaining 42% of total profit variability, but represented the second most important variable for the two lighter weight categories. Together, fed and feeder cattle prices explained from 70% to 80% of total profit variance.

Corn price was the third most important contributor to profit variance across all feeder weight categories. However, the impact of corn price was considerably greater for 600 to 699 lb placements, explaining 16% of this category's profit variance compared to 6% for 800 to 899 lb placements. Lighter weight placements consume considerably more total feed over the finishing period relative to heavier cattle. As a result, the profitability of light weight placements was more dependent upon fluctuating corn prices.

Feed conversion was the next most important explanatory variable, explaining 3% to 5% of profit variance. Finally, interest rates and daily gain combined explained approximately 2% to 4% of profit variance. Average daily gain was more important for cattle placed at heavier weights than for lighter weight cattle, reflecting the need to finish the expensive, heavy cattle quickly. Overall, animal performance explained 5% to 10% of profit risk.

Procurement or marketing strategies that help manage cattle price risk significantly influence profit risk. Producers placing light weight cattle need to be more concerned with fed cattle sale prices than those placing heavier cattle, because lighter cattle are on feed longer, allowing more time for significant fed cattle price changes between placement and slaughter. Producers placing light weight cattle should also be more concerned with feed grain price changes. Purchase price is the most important variable affecting profit for feeding heavy weight cattle. Feeding costs tend to be less critical with heavier placement weights than with lighter weights.

Table 1. Percentage of Total Explained Variability in Net Return of Steer Feeding over Time Attributable to Selected Factors, by Placement Weight, January 1980 to May 1991

Explanatory variable	Feeder placement weight		
	600 to 699 lb	700 to 799 lb	800 to 899 lb
----- % variability in net return explained -----			
Fed price	54.3	54.2	38.0
Feeder price	16.9	24.8	41.6
Corn price	15.9	8.9	6.3
Interest rate	2.2	1.0	-0.2
Feed conversion	3.1	3.5	4.8
Daily gain	0.4	1.4	3.7
Total explained ^a	92.8	93.8	94.3
Unexplained variability ^b	7.2	6.2	5.7

^aTotal percentage of variability in net return explained by variability in the explanatory variables.

^bUnexplained variability is 100 minus total explained.

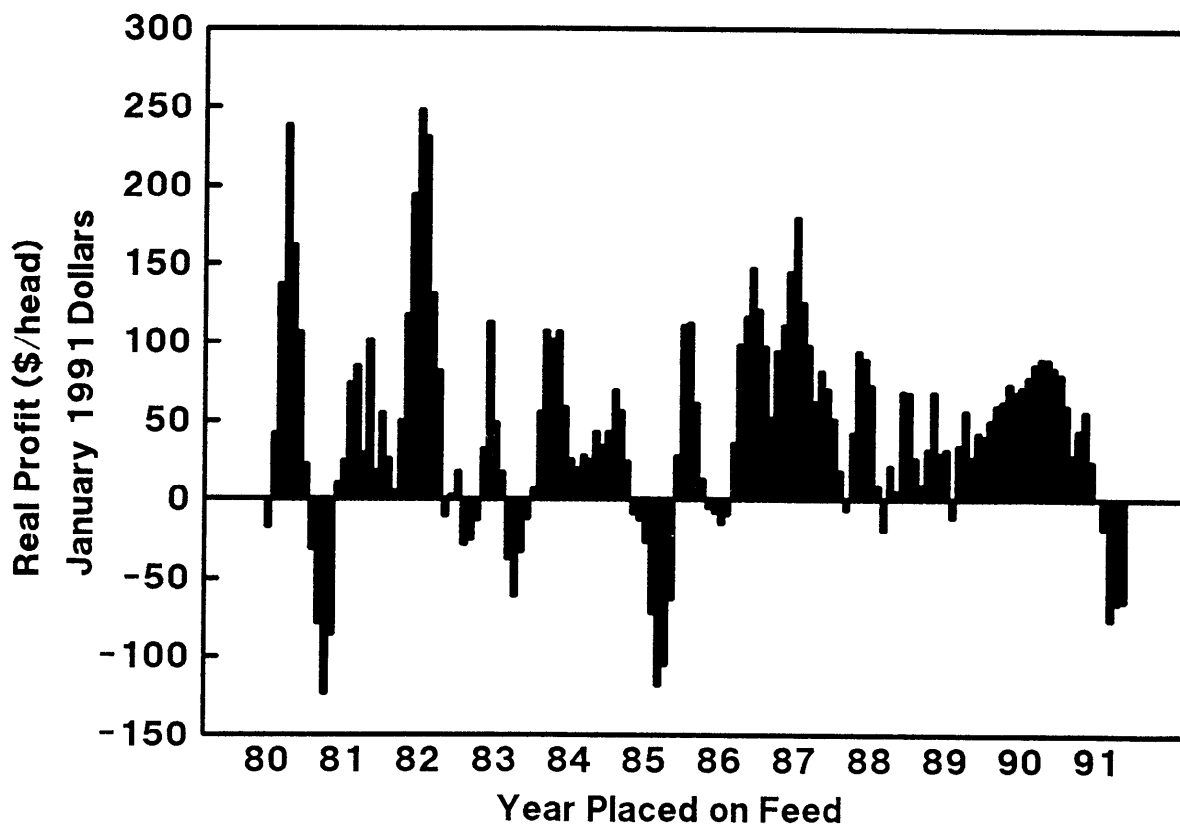

Figure 1. Monthly Average Profit from Feeding 700 to 799 lb Steers, Placed on Feed January 1980 through May 1991

FACTORS AFFECTING COST OF GAIN OF FEEDLOT STEERS

M. Albright¹, T. Schroeder¹, and M. Langemeier¹

Summary

This study examined the relative effects of corn price and cattle performance factors on steer finishing cost of gain. Seasonal analysis of cost of gain and the factors affecting it was also conducted. Using over 10 years of closeout data from two western Kansas feedyards, corn prices, feed conversion, and daily gain explained 93 to 94% of the variation in steer finishing cost of gain. About 60% of the variability was explained by corn price alone. Cost of gain and feed conversion rates were seasonally below average for steers placed in February through August. Daily gain was seasonally high for steers placed in March through August. Because cost of gain is heavily influenced by the volatility and seasonal patterns of corn price and cattle performance, cattle feeders should consider this information when making placement decisions.

(Key Words: Feedlot Cattle, Cost of Gain, Feed Conversion, Daily Gain.)

Introduction

Cost of gain is susceptible to fluctuations in feed prices, veterinary costs, yardage and processing fees, miscellaneous costs, and cattle performance factors. However, some of these factors have a relatively greater impact on steer finishing cost of gain. This study used fed steer closeouts from two western Kansas feedyards to estimate the relative importance of corn price and cattle performance factors on cost of gain.

Experimental Procedures

Closeout data on nearly 6700 pens of steers placed on feed from January 1980 through May 1991 were collected from two western Kansas custom feedyards. Only pens with steers averaging between 600 and 899 lbs at placement were used. The corn price used was the average Kansas price during the month the steers were placed on feed. Inflation was adjusted for by converting all cost and price data to January 1991 constant dollars.

Cost of gain is a function of input costs and cattle performance. Input costs include feed costs, veterinary costs, processing and yardage fees, and miscellaneous costs; and average daily gain, feed conversion, and death loss are key performance factors. Regression analysis was used to determine the relative contribution of each variable to the volatility in steer cost of gain over time.

Results and Discussion

About 93% of the variability in real cost of gain per cwt. over time was explained by corn price, feed conversion, and daily gain. Corn price and feed conversion were positively related to cost of gain, whereas daily gain was negatively correlated. The relative contribution of these factors to steer cost of gain over time is presented in Table 1. Overall, changes in corn price had more explanatory power for lighter placed steers; it accounted for 67% of the variation in cost of gain for 600 to 699 lb steers and 58% of the

¹Department of Agricultural Economics.

variation for 800 to 899 lb steers. Feed conversion had more influence on cost of gain as placement weight increased. For 600 to 699 lb steers, conversion explained 23% of the volatility in cost of gain, whereas it accounted for 33% of the variation for 800 to 899 lb steers. Finally, daily gain explained about 3% of the variability in steer finishing cost of gain.

placement weights. For lighter weight cattle, cost of gain variability was more heavily influenced by corn price, whereas variability for heavier weight steers was impacted more by changes in feed conversion. Further, cost of gain, feed conversion, and daily gain exhibited similar seasonal patterns for each placement category (Figures 1 to 3). Steers placed from approximately February through August had more advantageous cost of gain and performance factors.

Results from Table 1 show that corn price and feed conversion were effective in explaining cost of gain variability across

Table 1. Percent of Variation in Steer Finishing Cost of Gain Explained by Various Factors

Explanatory variable	Placement weight		
	600 to 699 lb	700 to 799 lb	800 to 899 lb
----- % of variability explained -----			
Corn price	66.9	65.1	58.4
Feed conversion ^a	22.9	25.7	32.8
Daily gain	3.1	2.6	2.6
Total explained ^b	92.9	93.4	93.8
Unexplained variability ^c	7.1	6.6	6.2

^aFeed/gain expressed on an as-fed basis.

^bTotal percentage of variability in cost of gain accounted for by volatility in the explanatory variables.

^cUnexplained variability is 100 minus total explained.

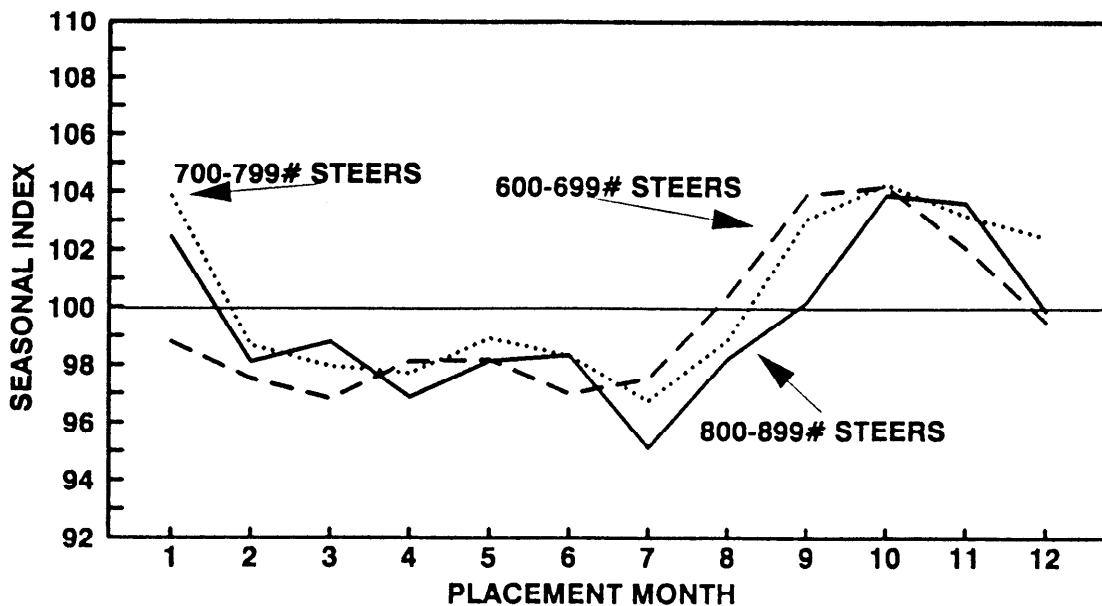

Figure 1. Seasonal Index of Real Cost per Cwt. of Gain for Steers Placed on Feed January 1980 through May 1991

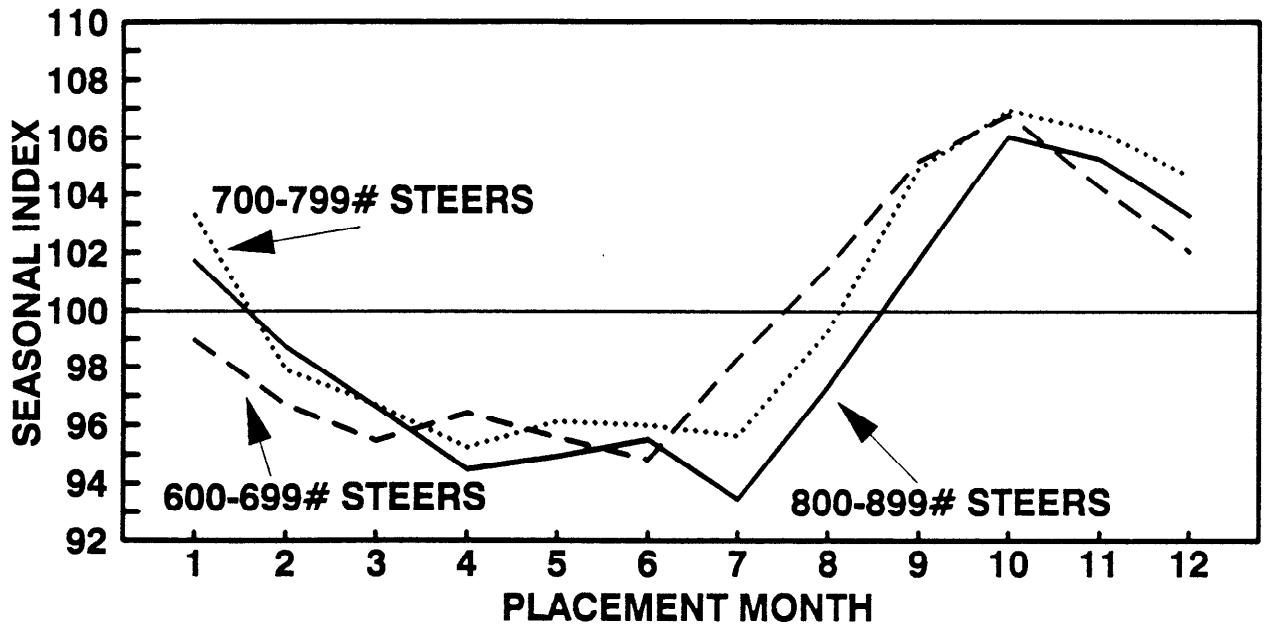

Figure 2. Seasonal Index of Feed Conversion for Steers Placed on Feed January 1980 through May 1991

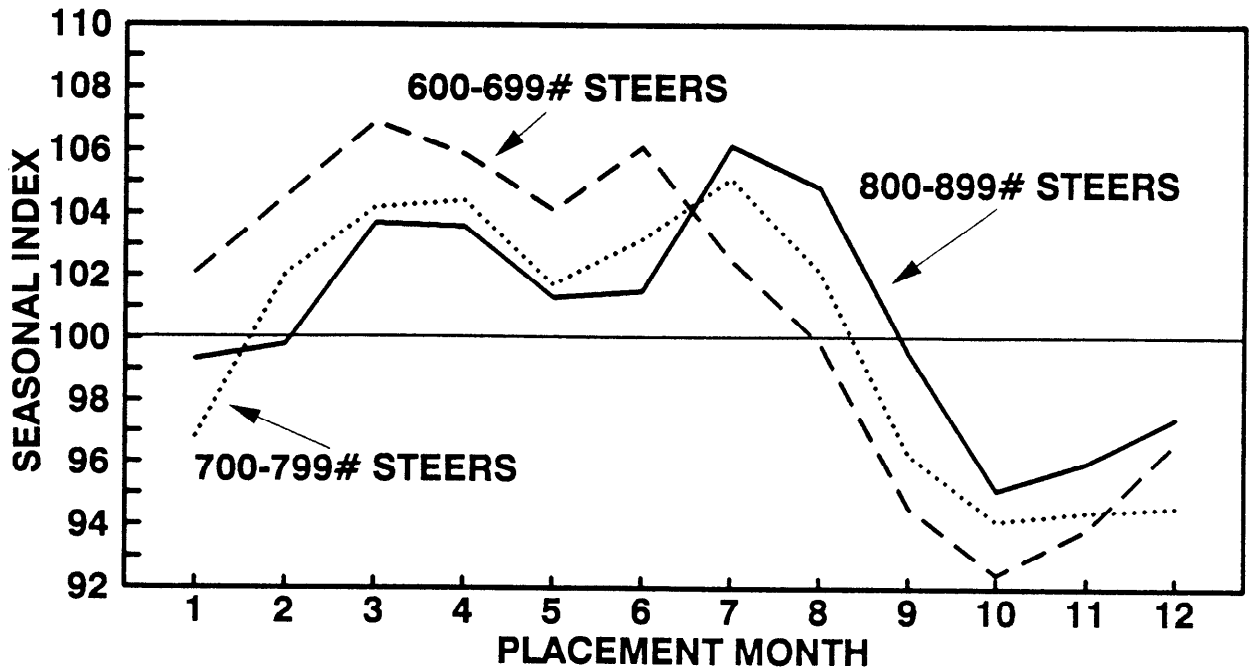

Figure 3. Seasonal Index of Average Daily Gain for Steers Placed on Feed January 1980 through May 1991

FACTORS THAT INFLUENCE NUMBER OF BIDS ON FINISHED CATTLE

T. Schroeder¹, J. Mintert¹, and R. Jones¹

Summary

Previous research indicates that the number of bids received on pens of fed cattle has a positive influence on price. This study was undertaken to determine what factors influence the number of bids received on pens of cattle. The number of bids for fed cattle was investigated in 13 southwestern Kansas feedyards during May through November, 1990. Results indicated that cattle of desired weight, with higher estimated carcass yield and quality grade, in larger pen sizes, and sold in the middle of the week received the most bids. In addition, feedyard asking price relative to packer price offers also influenced the number of bids received.

(Key Words: Marketing, Feed Cattle, Bid Determinants, Number of Bids.)

Introduction

Generally, the more bids a pen of feedlot cattle attracts, the higher the demand for that pen and the higher the resulting price. To the extent that a feedyard manager can either adjust production or marketing strategies to influence the number of bids, this knowledge of bid determinants will be valuable.

Experimental Procedures

Detailed bidding data were collected on 1405 pens of fed cattle sold during May through November 1990 in 13 feedyards in southwestern Kansas. The total number of bids received was collected on each pen sold. In

addition, several measures of animal quality, including live estimates of dressing percentage and USDA quality grade, and other characteristics of each pen, were collected, as well as market conditions in the region. These data were then statistically analyzed to estimate determinants of the number of bids received.

Results and Discussion

The majority (67.7%) of pens were sold on the first bid, and 83.6% of the pens had only one packer bid. In addition, packers often purchased several pens from a feedyard in a single negotiated transaction, which resulted in fewer total bids. The average numbers of cattle purchased by a packer from each yard daily were 679 head, when at least one pen of steers was purchased, and 580 head, when at least one pen of heifers was purchased. On average, five or more pens per yard were purchased daily by a packer. This suggests that the high bidding packer at a particular yard on any given day tended to be the high bidder on several pens of cattle.

The number of bids received per pen of cattle ranged from one to nine, with an average of 1.75 bids. Bid numbers were significantly influenced by live weight, with cattle weighing approximately 1144 lb receiving the most bids. This is consistent with packers stated preference for cattle in desired weight ranges. Table 1 reports the impacts of cattle quality variation, number of head, and feedyard asking price relative to packer's first offer on the number of bids received. For each 10% estimated increase in cattle grading Choice, the

¹Department of Agricultural Economics.

probability of receiving an additional bid was 4%, and the average number of additional bids was .5. The probability of attracting an additional bid was 15.4% for each 1% increase in estimated dressing percentage. The probability of the feedyard manager waiting for an additional bid increased 5% for each additional 100 head in a pen. Finally, for every \$/cwt that the asking price exceeded the packer's initial price bid, the probability that the feedyard manager would hold the cattle for an additional bid was 33.6%.

The average number of bids received varied by day of the week on which the cattle were sold. Figure 1 illustrates the average number of bids received per pen as the week progressed. Cattle sold on Monday and Tuesday received fewer bids, partly because they were on the show list for less time. Cattle sold on Wednesday attracted the most bids. Pens sold in mid-week included cattle that feedyard managers were reluctant to sell early in the week. Finally, cattle sold on Friday received fewer bids on average, perhaps reflecting reduced buyer interest in lower quality or underfinished cattle that remained on the show list.

Table 1. Impacts of Cattle Quality, Number of Head, and Feedyard Asking Price Relative to Packer First Price Offer on the Number of Bids Received

Bid factor	% Change in probability ^a	Number of additional bids ^b
Percent Choice ^c	4.00	.50
Dressing percent ^d	15.40	.21
Number of head ^e	5.00	.00
Asking price - bid spread ^f	33.60	.48

^aThe probability of receiving at least one more bid for each unit increase in the bid factor.

^bNumber of additional bids for each unit increase in the bid factor.

^c10% increments in estimated Choice cattle.

^d1% increments in estimated dressing percentage of cattle.

^e100 head per pen increments.

^f\$/cwt price spread increments.

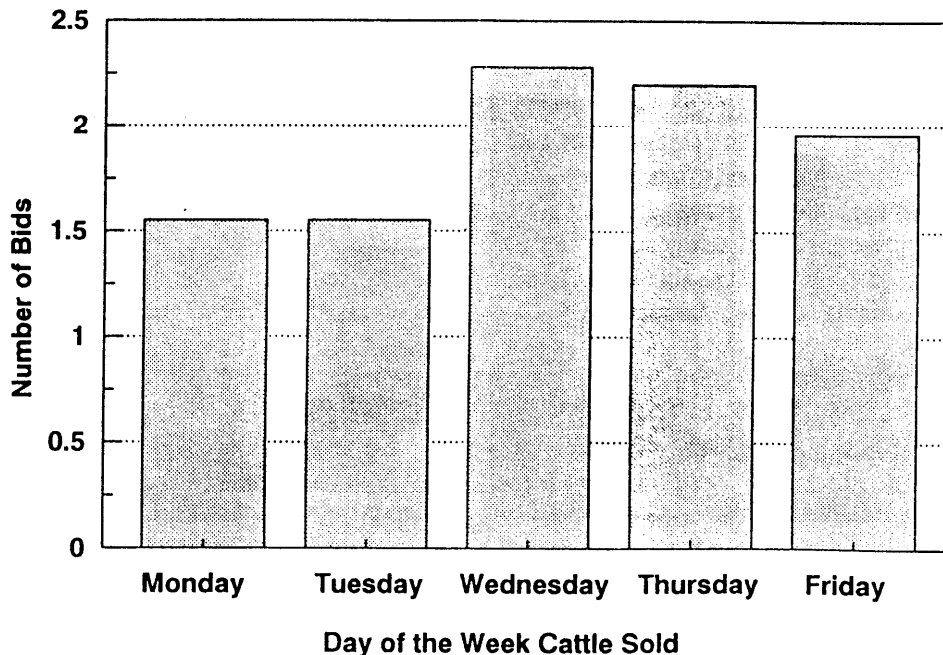

Figure 1. Average Number of Bids Received per Pen by Day of the Week Cattle Sold

RESULTS OF A PRODUCTION ANALYSIS SURVEY OF COW HERDS IN KANSAS

*D. Simms, M. Langemeier¹,
S. Utter, G. Fike, and C. Bandyk*

Summary

A survey of production levels and management practices of 205 cow herds representing over 26,000 cows in Kansas was conducted in 1991. These operations were located throughout Kansas except for the Northwest corner. Emphasis was placed on determining levels of production and reproductive parameters. Breeders emphasized calf crop. For example, the average calf crop was 91.6%, with 4.3% open females and 4.4% calf death loss. Cumulative calving percentages by 21-day calving periods were 32, 55, and 68%. Average weaning weights were 550 lb. for steers and 515 lb for heifers. Additionally, information was collected on breeding, nutrition, health, and general management practices.

(Key Words: Cow/Calf, Production, Reproduction, Management, Survey.)

Introduction

Surveys of production levels and management practices are useful to provide comparison data for producers and to document problem areas for Extension and research personnel. This survey was part of the Kansas Integrated Resource Management (IRM) Program.

Experimental Procedures

The surveys were conducted in the fall of 1991 and early winter of 1992 and represented the calf crop weaned in 1991. To increase accuracy, all forms were completed during on-farm visits. In tabulating the reproductive parameters, producers accounted for all females originally exposed and all subsequent reproductive losses. Those surveyed were all members of the Kansas Farm Management Associations and expressed an interest in participating. Consequently, the information collected does not represent a random sample; however, it does represent a diverse group of Kansas operations with various calving seasons and production systems.

Size of Herds

Total Number of Herds	205	
Total Females Exposed	26,015	
Average Herd Size	127	
Herd Size Profile		
Number of Cows	No. of Herds	%
Less than 50	26	13
50 - 100	66	32
101 - 150	58	28
> 150	55	27

¹Department of Agricultural Economics.

Reproductive Efficiency

Item	Avg.	Range
Open Females	4.3%	0.0 - 19.0%
Calf Death Loss	4.4%	0.0 - 16.5%
Calf Crop	91.6%	75.6 - 100%
Calving Distribution (Based on 155 Herds)		Avg.
Born in First 21 Days		32%
Born in First 41 Days		55%
Born in First 63 Days		68%
Heifers Requiring Calving Assistance -- 21.9%		
Heifers Requiring Mechanical Puller -- 14.6%		

Production

Spring Calving Herds:
Avg. Steer Weaning Weight = 545 lbs
Avg. Heifer Weaning Weight = 512 lbs
Fall Calving Herds:
Avg. Steer Weaning Weight = 611 lbs
Avg. Heifer Weaning Weight = 570 lbs
All 205 Herds:
Avg. Steer Weaning Weight = 550 lbs
Avg. Heifer Weaning Weight = 515 lbs

Breeding Program

Breed of Bulls Used on Heifers		Breed of Bulls Used on Mature Cows	
Sire	%	Sire	%
Angus	40	Angus	26
Salers	11	Simmental	18
Polled Hereford	8	Horned Hereford	10
Horned Hereford	7	Limousin	9
Limousin	7	Salers	9
Simmental	6	Gelbvieh	8
Longhorn	5	Polled Hereford	7
Gelbvieh	4	Charolais	5
Red Angus	3	Brangus	2
Brangus	2	Red Angus	1
Brahman	2	Shorthorn	1
Other	5	Chianina	1
		Maine Anjou	1
		Other	2

Method of Obtaining Herd Replacements	
Option	%
1) Purchase Yearling Heifers	2
2) Purchase Bred Heifers	5
3) Purchase Mature Cows	10
4) Raise Replacements	83
Herds with Crossbreeding Plan -- 36%	

Source of Bulls	
Source	%
Direct from Breeder	88
Raise Own	16
Test Station	15
Consignment Sale	7
Salebarn	5

Breeding Program (CONT)

Selection Criteria Used for Heifers:		
Criteria	First Consideration, %	Among Top 5 Criteria, %
Type/Conformation	24	66
Disposition	13	62
Performance of Dam	13	40
Size	10	41
Frame	9	49
Weaning Weight	9	31
Weight-for-Age	7	32
Yearling Weight	3	20

Selection Criteria used for Bulls:		
Criteria	First Consideration, %	Among Top 5 Criteria, %
Type/Conformation	19	55
Birth Wt/Calv. Ease EPD	19	50
Actual Birth Weight	14	45
Wean./Yearling Wt EPD	9	40
Frame	7	34
Breeder Reputation	5	17
Performance of Sire	5	14
Disposition	4	30

General Management

Management Factors	%
Breed Heifers Prior to Cows	49
Individually ID Calves	72
Cull - Open Heifers	95
- Heifers that Lose a Calf	65
- Open Cows	96
Separate Cows that Have Calved from the Herd	31
Supply Extra Feed for:	
- Heifers	76
- Young Cows	66
- Old Cows	54
Implant Steer Calves Prior to Weaning	84
Implant Heifer Calves Prior to Weaning	57
Creep Feeding:	
No Creep Feed	74
Grain Creep	18
Forage Creep	5
Protein Creep	3
Semen Check:	
Yearling Bulls	69
Mature Bulls	51
Individually Weigh Calves at Weaning	15

Feeding Program

NOTE: In the following sections, many producers listed more than one feedstuff, method of feeding, or supplement, indicating that a variety was typically utilized. This results in over 100% for total responses.

Range Management	%
Have Good Grazing Distribution	87
Practice Rotation Grazing	45

Method of Feeding Forage	%
Fed on Ground	42
Fed in Feeders	57
Forage Ground and Mixed	31

Common Winter Supplements	%
High Protein (all natural)	26
High Protein (with urea)	15
Low Protein	10
Liquid Supplement	4
Grain	44
Legume Hay	64

Feeding Program (CONT)

Primary Winter Forages	%
Range Grazing	38
Milo Stubble	40
Legume Hay	50
Sorghum Silage	18
Cane Hay	25
Corn Stalks	16
Grass Hay	5
Corn Silage	5

Percentage of Producers Using Specific Mineral Supplements by Season			
Supplement	Summer	Winter	Fall
Salt	92	79	77
TM Salt	69	70	53
High P	79	95	68
High Ca	50	57	41
High P with Mg	15	19	85
Other	12	11	9

Form of Mineral Supplementation	%
Mixed in Ration	7
Blocks	25
Loose, free choice	91

Health Program

Percentage of Herds Indicating Specific Disease Problems during Past Few Years			
Disease	%	Disease	%
Scours	39	IBR	5
Pinkeye	32	BVD	5
Respiratory*	24	Blackleg	3
Foot Rot	19	Lepto	3
Coccidiosis*	14	Vibriosis	1
Cancer eye	8	Other	7

*In many cases, this was observed postweaning.
 Abortions: 14% of herds had 1 or more abortions
 - calculated avg. abortion rate = .2%, range 0 to 2.9%

Deworming Programs:	%	Type Used	%
Don't Deworm	13	Injectable	57
Cows Annually	9	Paste	8
Calves Annually	23	Drench	11
Cows and Calves	43	Feed	4
Cows Periodically	12	Pour-on	6

Grub and Lice Control	%	Fly Control	%
Don't Treat for Grubs and Lice	10	No Control	14
Treat Cows	4	Ear Tags	53
Treat Cows and Bulls	17	Dust Bags	35
Treat Cows, Bulls, and Calves	69	Back Rubber	20
		Spray	28
		Fly Control	
		Mineral	20

Vaccination Program

Percentage of Cowherds Vaccinating for Specific Disease				
Disease	Cows	Heifers	Calves	Bulls
Vibriosis	66	68	8	44
Leptospirosis	75	79	12	52
Blackleg	22	44	93	15
Brucellosis	11	54	13	2
IBR	40	52	64	24
BVD	39	50	62	23
PI ₃	34	44	56	21
Scours	23	23	10	2
Haemophilus	13	18	29	8
Pinkeye & Other	14	13	26	11

IMPLANT COMPARISONS IN FEEDLOT STEERS AND HEIFERS

T. P. Eck¹ and L. R. Corah

Summary

Feedlot performance of steers implanted with Compudose®, Implus-S®, or Synovex-S® was very similar. No statistical differences were detected among treatments. However, implanted steers gained an average of 4% faster than nonimplanted controls. Carcass quality was virtually unaffected by treatment.

Implanting feedlot heifers with Synovex-H®, Implus-H®, or Implus-H® plus Finaplix-H® increased daily gain compared to non-implanted heifers. Implanting improved gain and feed efficiency by 13 and 7.1%, respectively, compared to controls. Differences in carcass characteristics probably were due to the increased weight gain associated with implants. Percentage of carcasses grading Choice was not impacted by treatment.

(Key Words: Feedlot, Steer, Heifer, Implants.)

Introduction

Improved gain and feed efficiency in feedlot cattle from growth promoting implants have been well documented. In addition, implants usually increase muscle growth, resulting in leaner carcasses. Two studies were conducted in southwest Kansas feedlots to evaluate the relative effects of currently available implants on live performance and carcass characteristics of feedlot steers and heifers.

Experimental Procedures

Two hundred and fifty steers averaging 711 lb were allotted to 16 pens with four weight replicates and given one of four implant treatments: Compudose, Implus-S, Synovex-S, and Control (no implant). The trial lasted 117 days and was conducted at Brookover Ranch Feedyard, Garden City, KS.

In the heifer study, 360 heifers averaging 639 lb were allotted to 20 pens with four weight replicates and given one of five implant treatments: Finaplix-H, Implus-H, Synovex-H, a combination of Implus-H and Finaplix-H, and Control (no implant). This study lasted 135 days and was conducted at Reeve Cattle Company, Garden City, KS.

In both trials, individual animal weights were taken at the beginning of the study. To obtain final individual live weights, about one week before slaughter, cattle in each pen were weighed as a group, then each animal was weighed individually. Individual weights were prorated back to the pen weight, and that figure used to compute final individual weights. Daily gains were calculated by shrinking individual final live weights 4%. Feed intake was expressed on a dry matter basis. Cattle were fed and managed according to the standard practices of the respective feedlots. Finishing diets were high in concentrate, typical of High Plains feedyards. In the heifer study, MGA® was not fed. All implant treatments were single dose without re-implantation.

¹Extension Livestock Specialist, Southwest Kansas.

Results and Discussion

Steer Results. Daily gain, feed intake, and feed efficiency were not affected statistically ($P > .05$) by implant treatment (Table 1). However, implanted steers gained 4% faster and ate 2% more feed daily than nonimplanted controls. Dressing percentage averaged 64.1 for all steers, based on feedlot shipping weight on the day of slaughter. Dressing percentages by treatment were not estimated, because individual steer weights were taken 7 days prior to slaughter. Carcass measurements were essentially unaffected by treatment, with the exception of fat thickness and yield grade (Table 2). Steers implanted with Compudose or Implus-S had greater ($P < .05$) external fat cover and higher yield grades than control steers, and Synovex-S steers were intermediate. These effects likely were due to the heavier carcass weights resulting from slightly higher gains, the slightly smaller ribeye areas, and the greater backfat thickness of steers implanted with Compudose and Implus-S. Percentage of carcasses grading USDA Choice or higher was not influenced ($P > .05$) by treatment.

Heifer Results. Except for Finaplix-H, implanting heifers increased ($P < .05$) daily gain compared to controls (Table 3). However, the gains of heifers implanted with

either Finaplix-H, Synovex-H, or Implus-H were statistically similar. The combination of Implus-H and Finaplix-H resulted in higher ($P < .05$) gains than either controls or Finaplix-H alone, but gain was not different than that with Synovex-H or Implus-H. Feed intake was not altered ($P > .05$) by treatment. Feed efficiency was improved ($P < .05$) in heifers receiving the combination implant compared to other treatments, except Synovex-H. Overall, the implant treatments resulted in a 13% increase in gain and a 4.5% increase in dry matter intake, compared to nonimplanted heifers. Implanting also improved feed efficiency 7.1%.

Dressing percentage averaged 64.8% for all heifers, based on feedlot shipping weight on the day of slaughter. As with the steers in the previous study, dressing percent was not separated by treatment, because individual weights were taken 6 days prior to slaughter. Differences in daily gain were also reflected in hot carcass weight and ribeye area (Table 4). Implanted heifers had larger ($P < .05$) carcasses and ribeyes than nonimplanted heifers. Other carcass measurements were not influenced by treatment. Yield grade and percentage of carcasses grading USDA Choice or higher were not affected ($P > .05$) by implant treatment.

Table 1. Effect of Implants on Steer Feedlot Performance

Item	Control	Compudose	Implus-S	Synovex-S	SEM ^a
Daily gain, lb	3.62	3.77	3.82	3.74	.08
Daily DM intake, lb	21.05	21.79	21.58	20.89	.44
Feed DM/gain	5.67	5.78	5.62	5.59	.14

^aPooled standard error.

Table 2. Implant Effects on Carcass Characteristics of Feedlot Steers

Item	Control	Compudose	Implus-S	Synovex-S	SEM ^a
Carcass wt, lb	738.3	754.0	757.3	733.8	10.0
KPH ^b , %	2.38	2.38	2.39	2.39	.02
Backfat, in.	.36 ^x	.42 ^y	.42 ^y	.40 ^{xy}	.01
Ribeye area, in. ²	12.46	12.11	12.03	12.30	.16
Yield grade	2.69 ^x	3.00 ^{yz}	3.05 ^y	2.85 ^z	.05
USDA Choice, %	66.9	71.3	61.0	73.4	5.4

^aPooled standard error.

^bKidney, pelvic, and heart fat.

^{xyz}Means in a row with unlike superscripts differ (P < .05).

Table 3. Effect of Implants on Heifer Performance

Item	Control	Synovex-H	Implus-H	Finaplix-H	Implus-H & Finaplix-H	SEM ^a
Daily gain, lb	2.28 ^x	2.60 ^{yz}	2.52 ^{yz}	2.48 ^{xy}	2.71 ^z	.07
Daily DM intake, lb	15.13	15.89	16.06	15.68	15.60	.29
Feed DM/gain	6.63 ^x	6.12 ^{xy}	6.39 ^x	6.36 ^x	5.76 ^y	.19

^aPooled standard error.

^{xyz}Means in a row with unlike superscripts differ (P < .05).

Table 4. Implant Effects on Carcass Characteristics of Feedlot Heifers

Item	Control	Synovex-H	Implus-H	Finaplix-H	Implus-H & Finaplix-H	SEM ^a
Carcass wt, lb	601.5 ^x	640.33 ^y	628.73 ^y	628.80 ^y	649.35 ^y	7.31
KPH ^b , %	2.58 ^{xyz}	2.46 ^{xy}	2.35 ^x	2.72 ^z	2.62 ^{yz}	.08
Backfat, in.	.57	.59	.61	.62	.61	.02
Ribeye area, in. ²	11.37 ^x	12.24 ^y	12.21 ^y	11.96 ^y	12.40 ^y	.15
Yield grade	3.04	2.98	2.97	3.15	2.99	.10
USDA Choice, %	75.7	58.7	58.8	71.2	62.1	5.5

^aPooled standard error.

^bKidney, pelvic, and heart fat.

^{xyz}Means in a row with unlike superscripts differ (P < .05).

COMPARISON OF SYNOVEX-S® AND TWO LEVELS OF REVALOR-S® IN HEAVY-WEIGHT HOLSTEIN STEERS¹

*G. L. Kuhl, D. D. Simms, D. A. Blas²,
and C. L. Kastner*

Summary

In two field trials, 434 Holstein steers averaging 849 lbs were assigned randomly to three single implant treatments: 1) Synovex-S®, 2) Revalor®-S 120 (120 mg trenbolone acetate (TBA) + 24 mg estradiol), and 3) Revalor®-S 140 (140 mg TBA + 28 mg estradiol). Revalor-implanted steers gained .05 to .10 lb per day faster, but this improvement was not statistically significant ($P > .05$). Both Revalor-implanted groups produced trimmer carcasses with less ($P < .05$) backfat than Synovex steers. All other carcass characteristics and beef sensory properties, including taste panel evaluations of tenderness, juiciness, and flavor, were not influenced by implant used.

(Key Words: Synovex, Revalor, Holsteins, Feedlot, Carcass Traits.)

Introduction

The implant Revalor was recently approved for use in feedlot steers at a dosage of 120 mg trenbolone acetate (TBA) and 24 mg estradiol. Some research has indicated that a higher dosage of Revalor may give superior performance, especially in heavy-weight cattle. Also, there has been some question as to whether Revalor reduces carcass merit and

palatability of the beef produced. Moreover, no U.S. research has been conducted with Revalor in Holstein steers. Thus, our objectives were to evaluate the use of Synovex-S versus two dosages of Revalor-S on steer performance, carcass characteristics, and beef palatability of heavy-weight Holsteins managed under commercial cattle feeding conditions.

Experimental Procedures

In field trials at two commercial feedyards, 434 heavy-weight Holstein steers averaging 849 lbs were assigned randomly within four feedlot pens to three implant treatments: 1) Synovex-S (200 mg progesterone + 20 mg estradiol benzoate); 2) Revalor-S 120 (120 mg TBA + 24 mg estradiol, the currently approved dosage); or 3) Revalor-S 140 (140 mg TBA + 28 mg estradiol). The feeding periods ranged from 102 to 134 days per pen, with an average of 117 days. The steers were slaughtered at a commercial packing plant, and individual hide-pull scores and carcass data were collected. Rib sections were obtained from a random sample of steers from one of the slaughter groups. Cooked steaks from these rib sections were prepared according to guidelines of the American Meat Science Association and mechanically measured for tenderness using a Warner-

¹Sincere appreciation is expressed to Ward Feed Yard, Larned and Pratt Feeders, Ashland, KS for providing cattle, facilities and management expertise; to Excel Corporation, Dodge City, KS for assistance with carcass evaluation; and to Hoechst Roussel Agri-Vet Co., Somerville, NJ for partial funding support of these studies. Special thanks also to Kelly Kreikemeier, Scott Hannah and County Extension Agricultural Agents Ricky Nelson and Robert Frisbie for assistance in data collection.

²Extension Livestock Specialist, South Central Kansas.

Bratzler Shear. Additionally, a trained, six-person, sensory panel evaluated the steaks for tenderness, juiciness, flavor, and overall palatability.

Results and Discussion

Steers receiving both Revalor implants gained .05 to .10 lb per day faster than the Synovex steers, but the differences were not significant ($P > .05$), as shown in Table 1. At slaughter, mechanical hide-pull scores were not influenced by implant. Carcasses of Revalor-implanted steers had less ($P < .05$) backfat and tended to have larger ribeyes than those of Synovex-S steers. The percentage of carcasses grading USDA Choice and

other quality and yield grade components were not influenced ($P > .05$) by implant. Additionally, tenderness of cooked steaks, as determined both mechanically and by the trained taste panel, and juiciness and flavor sensory evaluations were similar.

In summary, although these trials showed less numerical improvement in gain with Revalor compared to other research, they documented that a single implantation with Revalor had no negative impact on carcass merit or beef eating qualities compared to a Synovex implant in Holstein steers. Furthermore, there was no advantage to the higher dosage of Revalor.

Table 1. Comparison of Synovex-S versus Two Dosage Levels of Revalor-S in Heavy-Weight Holstein Steers

Item	Synovex-S	Revalor 120	Revalor 140
Animal Performance:			
No. of steers	146	143	145
Final wt, lb	1262	1274	1268
Daily gain, lb	3.54	3.64	3.59
Carcass Characteristics:			
Hot carcass wt, lb	762	769	765
Backfat thickness, in.	.24 ^d	.22 ^e	.22 ^e
KPH fat ^a , %	2.5	2.5	2.5
Ribeye area, sq. in.	11.3	11.7	11.6
Yield grade	2.9	2.8	2.8
Marbling score ^b	245	229	230
USDA Choice, %	85	85	78
Meat Quality:			
No. of carcasses tested	18	15	19
Warner Bratzler Shear force, lb	8.1	7.8	7.9
Taste panel evaluation ^c :			
Tenderness	6.3	6.1	6.4
Juiciness	6.3	5.9	6.1
Flavor	6.1	5.9	6.1
Off-flavor	7.8	7.8	7.8

^aKidney, pelvic, and heart fat.

^b100 to 199 = Slight, 200 to 299 = Small degrees of marbling.

^cAll taste-panel scores were based on an 8-point scale, with 8 the best rating possible.

^{d,e}Values with unlike superscripts are different ($P < .05$).

SEQUENTIAL IMPLANT STRATEGIES WITH SYNOVEX-S® AND TRENBOLONE ACETATE-CONTAINING IMPLANTS IN CALF-FED HOLSTEIN STEERS¹

D. D. Simms and G. L. Kuhl

Summary

In a commercial feedyard trial, 242 Holstein steer calves averaging 378 lb were used to compare effects of six alternative implant programs, consisting of sequential use of Synovex-S® or a combination of estradiol and trenbolone acetate (Revalor-S® or Finaplix-S® plus Synovex-S®), on feedlot performance and carcass characteristics. The calves were implanted three times at 78- to 90-day intervals while on feed an average of 252 days. The combination implant increased ($P < .05$) gain by .13 to .21 lb per day in all three implant periods compared to Synovex alone. Total feedlot gain was increased in direct relation to the number of times steers received the combination implant. However, marbling score and the percentage of carcasses grading USDA Choice tended to be reduced with repeated use of Revalor or Finaplix.

(Key Words: Revalor, Trenbolone Acetate, Finishing, Holsteins, Carcass Traits.)

Introduction

Large numbers of Holstein steer calves are fed in Kansas feedlots. Because these calves are on feed longer than the effective payout period of currently available implants, reimplanting is a common practice. Furthermore, the introduction of implants combining trenbolone acetate (TBA, a synthetic testos-

terone-like compound) and estradiol has raised questions regarding the optimum implant strategy for light-weight calves. This study was conducted to compare the relative effectiveness of six implant strategies on feedlot gain and carcass characteristics of Holstein steer calves.

Experimental Procedures

Holstein steer calves ($n = 242$) averaging 378 lb were assigned randomly within two pens to six sequential implant strategies. At the start of three consecutive implant periods, steers were implanted with either Synovex-S or a combination of TBA and estradiol. Revalor-S (120 mg TBA + 24 mg estradiol) was used in the first two implant periods, and the combination of Finaplix-S (140 mg TBA) plus Synovex-S (20 mg estradiol benzoate + 200 mg progesterone) was used at the start of the final period. The three implant periods averaged 84, 90, and 78 days, respectively. Individual calf unshrunk weights were used to calculate gains, except for final live weights, which were based on individual hot carcass weights and an average dressing percentage of 58.9%. Steers were slaughtered in a commercial packing plant, and individual hide-pull scores and carcass data were collected.

¹Sincere appreciation is expressed to Circle E Feedlot, Potwin, KS for providing cattle, facilities and management expertise; to Excel Corporation, Dodge City, KS for assistance with carcass evaluation; and to Hoechst Roussel Agri-Vet Co., Somerville, NJ for partial funding of this study. Special thanks also to Scott Hannah, Clyde Cranwell, Jason Apple, and Butler County Extension Ag Agent, Virgil Biby, for assistance with data collection.

Results and Discussion

Implanting with the combination of TBA + estradiol increased ($P < .05$) daily gain during each of the three implant periods by an average of 4.9, 4.0, and 7.9%, respectively, as shown in Table 1. Likewise, overall feedlot gain was increased in proportion to the number of times the implant combination was used. For example, steers receiving three combination implants gained faster ($P < .05$) than those receiving Synovex-S or the combination only once during the trial. The more rapid gains from repeated use of TBA and estradiol resulted in heavier ($P < .05$) final weights and carcasses.

Packing plant hide-pull scores were not influenced by implant treatment. Likewise, carcass backfat; the percentage of kidney, pelvic, and heart fat; and yield grade were similar for cattle on all implant strategies.

Ribeye area tended to be larger in steers that received the combination implant; however, most of that increase was explained by their more rapid gains and correspondingly larger carcasses, as shown by only small differences in ribeye area per 100 lb carcass weight. Both marbling score and the percentage of carcasses grading USDA Choice tended to be negatively influenced in direct proportion to the number of combination implants used. However, these quality differences were not significant ($P > .05$).

The combination of TBA and estradiol, either as Revalor or Finaplix + Synovex, presents the feedlot industry with a tradeoff between increased growth at the possible expense of carcass grade. Consequently, producers must evaluate the relative economic impact of these factors, considering the Holstein contract specifications commonly used by the beef industry.

Table 1. Comparison of Sequential Implanting Strategies with Synovex-S® and Trenbolone Acetate-Containing Implants in Fed Holstein Steer Calves

Item	Implant Treatment ¹					
	A	B	C	D	E	F
Implant combination	A	B	C	D	E	F
No. of steers	41	42	41	40	38	40
ANIMAL PERFORMANCE						
First Implant	<u>S</u>	<u>S</u>	<u>S</u>	<u>R</u>	<u>R</u>	<u>R</u>
Period length - 84 days						
Period gain, lb	292	284	287	300	301	305
Daily gain, lb	3.49	3.40	3.44	3.59	3.60	3.65
Period 1 daily gain by implant, lb: S = 3.44 ^a				R = 3.61 ^b		
Second Implant	<u>S</u>	<u>S</u>	<u>R</u>	<u>S</u>	<u>R</u>	<u>R</u>
Period length - 90 days						
Period gain, lb	291	292	300	296	294	319
Daily gain, lb	3.23	3.24	3.33	3.29	3.27	3.54
Period 2 daily gain by implant, lb: S = 3.25 ^a				R = 3.38 ^b		
Third Implant	<u>S</u>	<u>F&S</u>	<u>F&S</u>	<u>S</u>	<u>S</u>	<u>F&S</u>
Period length - 78 days						
Period gain, lb	186	198	212	192	203	216
Daily gain, lb	2.42	2.59	2.79	2.52	2.67	2.84
Period 3 daily gain by implant, lb: S = 2.54 ^a				F&S = 2.74 ^b		
Overall						
Total gain, lb	769 ^a	774 ^a	798 ^{ab}	788 ^a	794 ^{ab}	840 ^b
Daily gain, lb	3.09 ^a	3.11 ^a	3.21 ^{ab}	3.17 ^a	3.21 ^{ab}	3.38 ^b
Final wt., lb	1147	1152	1177	1167	1176	1218
CARCASS CHARACTERISTICS						
Hot carcass wt., lb	675 ^a	678 ^a	693 ^{ab}	687 ^a	692 ^{ab}	717 ^b
Backfat thickness, in.	.22	.21	.21	.24	.24	.23
KPH fat, %	2.5	2.5	2.5	2.5	2.5	2.7
Ribeye area, sq. in.	10.8	11.2	11.3	11.3	11.4	11.7
REA/cwt. HCW, sq. in.	1.61	1.66	1.63	1.64	1.65	1.64
Marbling score ^c	206	207	199	195	197	180
Yield grade	2.7	2.7	2.6	2.7	2.8	2.6
% Choice	68	60	59	63	45	40

¹S = Synovex-S, R = Revalor-S (TBA plus estradiol), F + S = combination of Finaplix-S (TBA), and Synovex-S (estradiol + progesterone) implants.

^{a,b}Values in the same row with unlike superscripts differ (P < .05).

^c100 to 199 = Slight, 200 to 299 = Small degrees of marbling.

ANTIMICROBIAL RESISTANCE AMONG IMPORTANT BOVINE PATHOGENS ISOLATED AT THE KSU VETERINARY DIAGNOSTIC LABORATORY OVER TWO AND A HALF YEARS

M. M. Chengappa¹, D. P. Rogers¹, and M. W. Vorhies¹

Summary

A retrospective study was conducted to determine the prevalence of antimicrobial resistance among six important bacterial pathogens of bovine origin. The study extended from June 1990 through December 1992 and included a review of the microbiology records of bovine submissions to the KSU Veterinary Diagnostic Laboratory. Antimicrobial susceptibility results for *Pasteurella haemolytica*, *Pasteurella multocida*, *Actinomyces pyogenes*, *Hemophilus somnus*, *Escherichia coli*, and *Salmonella* spp. are summarized. Pathogens were recovered primarily from cases of pneumonia and/or diarrhea. Each isolate was tested for susceptibility to 14 different antimicrobial agents. A high prevalence of resistance (> 70%) was noticed for respiratory pathogens to sulfa-chloropyridazine. In addition, *Pasteurella* spp. were very resistant (> 71%) to sulfadimethoxine. Most of the *H. somnus* isolates showed little resistance (< 35%) to 12 of the 14 drugs tested. *A. pyogenes* isolates were generally susceptible to most antimicrobials except sulfa drugs. As expected, a high prevalence of resistance (> 70%) was noticed for enteric pathogens (*Salmonella* and *E. coli*) to most of the antimicrobials tested.

(Key Words: Resistance, Disease, Bacteria, Treatment, Cattle.)

Introduction

Pneumonia and diarrhea in cattle of all ages can be initiated by a variety of microbial agents, but only the bacteria involved in these conditions are the major targets of antimicrobial therapy. Antimicrobial susceptibility profiles are important in determining appropriate therapy against those bacterial pathogens. A major problem facing veterinarians is deciding quickly what drug and dosage will be effective in treating cattle affected with these conditions. This is increasingly difficult, because drug resistance appears to be increasing steadily.

Because many bacteria develop resistance to antimicrobial agents, isolation of an infectious agent from an animal is often not sufficient to determine proper treatment. Susceptibility profiles of bacteria are constantly changing; thus, a veterinarian must know the antimicrobial sensitivity profile of bacteria in question before treatment. This retrospective study determined the prevalence of antimicrobial resistance among important cattle pathogens recovered from cases of pneumonia and diarrhea.

Experimental Procedures

Bacterial pathogens were recovered from cattle that had died from pneumonia and/or

¹KSU College of Veterinary Medicine, Department of Pathology and Microbiology, and Veterinary Diagnostic Investigation, respectively.

diarrhea and had been evaluated at the KSU Veterinary Diagnostic Laboratory between June 1990 and December 1992. The pathogens were isolated and identified biochemically and serologically using standard procedures. Susceptibility testing of bacteria was performed with the automated Sensititre System (Sensititre Microbiology System, Westlake, OH). The antimicrobial agents and their concentrations are presented in Table 1.

Results and Discussion

Enteric pathogens such as *Salmonella* and *E. coli* were more resistant to antimicrobials than pneumonic pathogens such as *Pasteurella*, *Haemophilus*, and *Actinobacillus* (Table 1).

This agrees with recent findings of other researchers. Ceftiofur (Naxcel®) still appeared to be very effective against all respiratory and enteric pathogens tested. However, these *in vitro* observations should be used only as a guide to antimicrobial selection. Resistance to these drugs may develop through increased use, so continued surveillance is warranted. In the present study, the animals or tissues evaluated tended to be from herds where treatment response was nil and death losses were heavy. Thus, these data represent the high prevalence of drug resistance among bacteria associated with cases of pneumonia and diarrhea. Specimens collected prior to death, during early course of disease, or prior to treatment also might show antimicrobial resistance.

Table 1. Percentage of Resistant Bacteria Recovered from Bovine Pneumonic and Diarrheic Cases

Antimicrobial agents ^a	<u>P. haemolytica</u>		<u>P. multocida</u>		<u>H. somnus</u>		<u>A. pyogenes</u>		<u>Salmonella</u>		<u>E. coli</u>	
	Total	% Res.	Total	% Res.	Total	% Res.	Total	% Res.	Total	% Res.	Total	% Res.
Ampicillin (2,4,8)	297	49	216	32	49	45	95	30	174	66	828	60
Ceftiofur (1,2) ^b	106	2	126	15	21	19	55	11	66	6	343	7
Cephalothin (8,16)	297	9	216	10	49	31	95	14	174	28	828	26
Enrofloxacin (1,4)	297	8	216	8	49	18	95	16	174	8	828	5
Erythromycin (0.5,4)	297	27	216	30	49	21	95	24	174	99	828	99
Gentamicin (4,8)	297	6	216	10	49	13	95	14	174	29	828	20
Neomycin (8)	297	34	216	49	49	27	95	49	174	66	828	58
Penicillin G (0.12,2)	297	51	216	35	49	27	95	18	174	99	828	99
Spectinomycin (8,16)	297	82	215	79	49	35	91	34	171	97	827	58
Sulfa-chloropyridazine (20,40)	106	68	126	79	21	39	55	80	66	90	343	87
Sulphadimethoxine (20,40)	106	72	126	71	21	25	55	69	66	99	343	94
Tetracycline (4,8)	297	52	216	36	49	17	95	26	174	78	828	79
Tribrisen (1/19,2/38)	106	11	126	13	21	20	55	44	66	15	343	34
Tylosin (5,10)	297	88	215	83	49	21	91	22	167	99	825	99

^aNumber in parentheses indicates concentration of drugs in µg/ml.

^bCeftiofur (Naxcel®) concentration was increased from .2 and .4 to 1 and 2 µg/ml on October 1, 1991.

INFLAMMATORY RESPONSE OF FEEDLOT CATTLE TO CLOSTRIDIAL VACCINATION: A COMPARISON OF 7-WAY BACTERIN-TOXOID AND C&D TOXOID

G. L. Stokka¹, R. T. Brandt, Jr., A. J. Edwards¹,
M. F. Spire¹, and J. E. Smith²

Summary

Twenty-four finishing steers (758 lb) were subcutaneously vaccinated and revaccinated 31 days later with 1) sterile saline, 2) a clostridial *perfringens* C&D toxoid, or 3) a 7-way clostridial bacterin-toxoid to evaluate the effects of vaccine type on inflammatory response in feedlot cattle. Injection site reactions were most severe ($P < .05$) and persistent for 7-way bacterin-toxoid and were accompanied by elevated ($P < .05$) blood haptoglobin levels indicative of acute inflammation. Revaccination with 7-way bacterin-toxoid reduced ($P < .05$) feed consumption for a 4-day period postvaccination. Although some reactions were severe, they appeared transient because blood parameters and volume of injection site reactions returned to baseline levels 25 to 60 days after injection. Performance over the entire feeding period was not significantly altered by treatment. We strongly recommend that clostridial products be used subcutaneously only, to minimize potential damage to carcass tissue from intramuscular injection.

(Key Words: Vaccination, Cattle, Injection Site.)

Introduction

Recent observations indicate that multiple clostridial bacterin-toxoids may contribute to localized inflammatory responses, depressed feed consumption postvaccination, and damage

to carcass tissue. In addition to heightened inflammation, the impact of depressed feed consumption can be direct, resulting in reduced gain, or indirect, through digestive upsets. Any factor that contributes to an unstable consumption pattern can increase bunk management problems and increase morbidity or mortality from bloat or other digestive disorders. Therefore, the purposes of this research were to: 1) evaluate injection site reactions resulting from clostridial vaccination; 2) examine the inflammatory response associated with clostridial vaccination; and 3) evaluate the impact on appetite associated with clostridial vaccination.

Experimental Procedures

Twenty four crossbred steers were selected for uniformity of size and conformation from a group of 108. All cattle were processed on January 20, 1992 using a 7-way clostridial product in combination with *Hemophilus somnus* (Ultrabac[®] 7/Somubac[™], SmithKline Beecham Animal Health, Exton, PA). On June 20, the calves received a 7-way clostridial booster. The steers were delivered to the KSU Beef Research Unit on June 30. On July 1 (day 1 of the trial), they were individually weighed (758 lb average), ear tagged, and randomly allotted to immunization treatments to be administered on day 15. Treatments were: 1) 5cc of sterile saline; 2) a clostridial vaccine consisting of the antigens of *Clostridium perfringens* type C&D in a 2cc dose (C&D; Ultrabac[®] CD, SmithKline Beecham

¹Clinical Sciences, KSU College of Veterinary Medicine.

²Pathology and Microbiology, KSU College of Veterinary Medicine.

Animal Health, Exton, PA); and 3) a clostridial vaccine consisting of the antigens of *Clostridium chauvoei*, *sordellii*, *septicum*, *novyi*, and *perfringens* type C&D in a 5cc dose (7-way, Ultrabac® 7).

On the last day of the 14-day feedlot acclimation period, the steers were weighed, blood was drawn, and any reactions from previous injections were noted. On the following day (day 15), the steers were vaccinated according to the random allotment they received on day 1.

All products were delivered subcutaneously using a skin tenting technique. Each animal was injected using a new, sterile, 16-gauge 3/4-inch needle. The hair over the injection site was clipped to identify the exact site of injection. The calves were weighed and bled on days 18, 21, 25, 30, and 40 and weighed again on days 46, 61, 136 and at slaughter. The second injection was given on day 46, on the left side of the neck. Blood analyses included cell counts and concentrations of aspartate amino-transferase, creatine phosphokinase, sorbitol dehydrogenase, gamma globulins, and haptoglobin. The length, width, and height of the injection site reactions were measured. Steers were individually fed a corn-based finishing diet formulated to contain 12% CP, 62 Mcal NEg, and 91 Mcal NEm/lb during the trial.

Results and Discussion

Inflammatory response. White blood cell counts, segmented neutrophils, lymphocytes, and gammaglobulin levels all showed small increases in response to treatment, but remained within or close to normal limits. Plasma protein and fibrinogen levels also showed slight increases but remained well within normal limits. Blood haptoglobin levels were increased after injection in the C&D and 7-way treatment groups, whereas the sterile saline group showed no change over time (Table 1). The response to C&D

and 7-way injection was greatest on day 3 postinjection. An increase in haptoglobin level is indicative of an acute inflammatory response.

Injection site reactions. Injection site reactions were noted in 100% of the clostridial-vaccinated calves within 24 hours after administration. The injection reactions were raised above the skin surface and varied in shape among animals. By day 3 when the sites were measured, the average involvement was 219 cc in the 7-way group vs 78 cc in the C&D group (Table 2; $P < .05$). No calves in the saline group developed injection site reactions. At the time of slaughter, no significant palpable lesions remained in either clostridial group.

Performance. Calf feed consumption was not significantly impacted during the 4-day period after the first injection, although intake declined 1%, 2%, and 10% for the saline, C&D and 7-way groups, respectively (Table 3). Following the second injection, consumption of the saline group increased 4%, whereas that of the C&D and 7-way groups declined 8% and 20% ($P < .05$), respectively. Although steer gains were not significantly influenced by treatment, steers in the 7-way group were 14 lb lighter at slaughter than the saline-injected steers.

These data suggest that injection of feedlot cattle with clostridial vaccines can result in a transient, yet significant, inflammatory response. Subcutaneous injection-site reactions may persist for months. Injection with 5 ml of 7-way bacterin-toxoid resulted in a more severe, longer lasting reaction than injection with 2 ml of C&D toxoid. Whether the reaction severity in the 7-way group was from the antigens themselves, or from higher levels of potentially irritating vaccine adjuvants, is unknown. Using clostridial products subcutaneously is strongly advised to minimize potential damage to carcass tissue.

Table 1. Blood Haptoglobin Levels (mg/dl) over Time from Steers in Response to Injection with Sterile Saline, C&D Toxoid, or 7-Way Bacterin-Toxoid

Day of trial	Saline	C&D	7-Way
Preinjection:			
Day 0	15.4	12.5	19.8
Postinjection:			
Day 3	15.2 ^a	35.8 ^b	47.0 ^b
Day 6	12.8 ^a	14.5 ^a	26.6 ^b
Day 9	11.5	11.4	11.6
Day 15	15.4	11.4	11.7
Day 25	11.2	12.4	11.8

^{a,b}Means in a row with unlike superscripts differ ($P < .05$).

Table 2. Volume (cm³) of Injection Site Reactions over Time from Steers in Response to Injection with Sterile Saline, C&D Toxoid, and 7-Way Bacterin-Toxoid

Day of trial	Saline	C&D	7-Way
Postinjection:			
Day 3	0 ^a	78 ^b	219 ^c
Day 6	0 ^a	52 ^b	113 ^c
Day 9	0 ^a	31 ^b	72 ^c
Day 15	0 ^a	21 ^b	75 ^c
Day 25	0 ^a	21 ^b	49 ^c
Day 31	0 ^a	8 ^a	51 ^b
Day 61	0 ^a	2 ^a	21 ^b
Slaughter	0	0	0

^{a,b,c}Means in a row with unlike superscripts differ ($P < .05$).

Table 3. Average Daily Feed Consumption (lb as-fed) by Steers during the Four-Day Preinjection and Four-Day Postinjection Periods

Item	Saline	C&D	7-Way
First Injection:			
Preinjection	20.2 ± 3.3	22.4 ± 2.9	21.8 ± 2.9
Postinjection	20.0 ± 4.2	22.0 ± 3.5	19.8 ± 3.1
Second Injection:			
Preinjection	26.8 ± 2.9	26.8 ± 3.3	26.0 ^a ± 2.6
Postinjection	27.9 ± 3.1	24.6 ± 2.2	20.9 ^b ± 4.0

^{a,b}Means for a treatment within an injection period differ ($P < .05$).

EFFECT OF ZINPRO 100® IN A MINERAL MIXTURE ON GAIN AND INCIDENCE OF FOOTROT IN STEERS GRAZING NATIVE GRASS PASTURES¹

F. K. Brazle²

Summary

In a 3-year study, crossbred steers averaging 585 lb were allotted to groups given either a control or zinc methionine-supplemented mineral mixture while grazing burned native pastures in early summer. The steers were monitored for weight gain and incidence of footrot. The addition of 100 lb Zinpro 100® (50% zinc methionine) per ton of free-choice mineral mixture improved ($P < .06$) steer daily gain .08 lb. and reduced the incidence of footrot 55% (5.38 vs. 2.45%; $P < .06$). The gain benefit could not be attributed entirely to reduced footrot, but appeared to also have a nutritional basis.

(Key Words: Zinc Methionine, Zinpro, Footrot, Native Grass, Stocker Cattle.)

Introduction

The incidence of footrot in cattle grazing native grass can range from 0 to 10%. Because these cattle are typically grazed in large pastures, treatment with injectable antibiotics also entails catching and restraining affected animals. Therefore, the best treatment is a preventative program. Zinpro 100 (zinc methionine) has been fed to feedlot cattle to reduce footrot and enhance performance. Therefore, our objective was to determine the influences of Zinpro 100® in a free-choice

mineral mixture on weight gain and incidence of footrot in grazing cattle.

Experimental Procedures

In three consecutive years, two hundred and forty-one crossbred steers averaging 585 lb were weighed and allotted randomly in late April to eight pastures and offered either a Zinpro 100 or control mineral supplement. The two mineral treatments were rotated by year through the native grass pastures. After grazing for an average of 93 days, steers were gathered from the pastures in early morning and commingled in pens before final weights were obtained. The mineral mixtures were fed in open wooden boxes, and intake was recorded weekly. Compositions of the free-choice mineral mixtures are shown in Table 1. The steers were observed once each week for visible signs of footrot, typically lameness. Twenty-seven steers were removed from the study over the 3-year period for lump jaw, respiratory problems, death, or in response to hail that reduced the available forage in one pasture (12 animals).

Results and Discussion

Adding zinc methionine to the mineral supplement of steers grazing native grass improved ($P < .06$) daily gain .08 lb as shown in Table 2. The incidence of footrot was reduced ($P < .06$) from 5.38% in control steers

¹Sincere appreciation is expressed to Zinpro Corp., Edina, MN for supplying zinc methionine (Zinpro-100®) and partial funding of this study. Sincere thanks also for use of the Bressner Field Research Pastures and to Dale Lanham, Woodson Country Extension Agricultural Agent, for assistance in data collection.

²Extension Livestock Specialist, Southeast Kansas.

to 2.45% in Zinpro-supplemented steers.

The average daily consumption of Zinpro 100 was 5.4 grams, or 2.7 grams of zinc methionine. This provided 540 mg of zinc in addition to 23 mg of zinc from the standard trace mineral pack, for a total of 563 mg/day of supplemental zinc. The control mineral mixture provided only 23 mg of zinc/day. Our best estimate of zinc provided by the grass is 226 mg/day, assuming 21 lb dry forage per day, 15.4 mg zinc/lb dry grass, and 70% zinc availability. Thus, total zinc consumption for the control steers averaged about 249 mg compared to about 789 mg for the Zinpro-supplemented cattle. The NRC zinc requirement for cattle is 30 ppm, or

286 mg/day. Therefore, zinc consumption by the control steers likely was 37 mg below NRC requirements, but steers offered the Zinpro mineral consumed almost 3 times the requirement.

Only a portion of the improvement in gain could be attributed to the lowered incidence of footrot. Cattle that had footrot gained 2.30 lb/day, whereas those not affected gained 2.76 lb/day. Multiplying that difference in gain by the percentages of steers that had footrot in the two mineral treatments only accounted for .013 lb/day difference in gain. Therefore, the benefits of supplemental zinc methionine for steers grazing native grass pastures appear to be nutritional as well as therapeutic.

Table 1. Composition of Control and Zinpro 100 Added Mineral Supplements

Ingredient	Control	Zinpro 100
	-----lb per ton-----	
Dried molasses	300	300
White salt	600	600
Trace mineral pack ^a	5	5
Monocalcium phosphate	500	500
Mineral oil	20	20
Bovatec [®] premix (68 grams/lb) ^b	21	21
Vitamin A premix (30,000 IU/g)	2	2
Limestone	300	250
Magnesium mica ^c	252	202
Zinpro 100 [®] (10% zinc from zinc methionine)	---	100

^aTrace mineral pack contained 35,000 ppm manganese, 7,500 ppm copper, 1500 ppm cobalt, 85,000 ppm zinc, and 45,000 ppm iron.

^bHoffmann-LaRoche, Inc., Nutley, NJ.

^cMicro-Lite Corp., Chanute, KS.

Table 2. Effect of Zinpro 100 in a Mineral Mixture on Gain and Incidence of Footrot of Steers Grazing Native Grass

Item	Zinpro 100	Control
No. steers	342	354
Starting wt, lb	583	587
Daily gain, lb	2.79 ^a	2.71 ^b
Incidence of footrot, %	2.45 ^b	
5.38 ^a		
Daily mineral intake, lb	.24	.22
Daily Zinpro 100 intake, g	5.40	-----

^{ab}Means in the same row with unlike superscripts are different (P < .06).

EFFECT OF MASS MEDICATION ON THE HEALTH AND GAIN OF CALVES IN GRASS PADDOCKS OR FEEDLOT PENS¹

F. K. Brazle²

Summary

Four hundred and ninety mixed-breed, long-hauled, bull calves averaging 275 lb were used in a winter study to determine whether mass medicating calves in grass paddocks or feedlot pens would reduce health problems and improve performance. All calves were started in feedlot pens for 3 days, then half of the calves were turned out into grass paddocks. Mass medication with injectable oxytetracycline did not improve health or gain of the calves. Calves housed in grass paddocks during the recurring period had less sickness ($P < .01$), fewer ($P < .05$) sick days per animal purchased, and lower ($P < .05$) drug treatment costs than their counterparts housed in feedlot pens.

Introduction

Factors affecting the health of newly arrived calves are important to all producers. The traditional method of receiving newly weaned calves had been to place them in small pens for at least 2 to 3 weeks, with the rationale that, if the calves are closer to feed and water, they should start eating sooner. However, stressful environmental conditions such as mud or dust can cause problems in small pens. Also, the higher population density encourages the spread of disease organisms. Therefore, the objective of this study was to compare housing newly received calves in grass paddocks vs. dirt pens, with or without mass medication.

Experimental Procedures

Four hundred and ninety mixed-breed, bull calves averaging 275 lb were purchased in the winter over a 5-day period from Tennessee and Mississippi and shipped to east central Kansas. The calves were allotted to four housing/medication treatments with two replications: 1) no medication in grass paddocks, 2) mass medication in grass paddocks, 3) no medication in feedlot pens, and 4) mass medication in feedlot pens. All calves were held in feedlot pens for the first 3 days, before assigned calves were turned onto grass paddocks. The 3-day period was necessary for the calves to settle down and become accustomed to feed bunks.

At arrival the calves were vaccinated against IBR, BVD, PI₃, and 7 clostridial organisms; treated for internal and external parasites with Ivomec®; implanted with Synovex-S®; and castrated. All calves, regardless of assigned treatment, were injected with long-acting penicillin (6 ml/100 lb body weight IM) at arrival. The experimental mass medication consisted of subcutaneously injecting the calves 12 times on days 3, 5, 7, 9, 11, 13, 15, 17, 19, 21, 24, and 27 with 10 ml/100 lb body weight of oxytetracycline hydrochloride (100 mg/ml).

Calves were offered a forage diet of one-half alfalfa and one-half prairie hay fed to appetite and were supplemented daily with 2.5 lb whole corn and .5 lb of a 40% protein pellet

¹Sincere appreciation is expressed to Richard Porter, Reading, KS for providing cattle and facilities.

²Extension Livestock Specialist, Southeast Kansas.

at the start of the 54-day receiving period. In 1 to 2 weeks, corn silage gradually replaced the prairie hay. All calves were fed the same amount of receiving ration per head daily. The 9-acre grass paddocks were long and narrow and had fence-line feedbunks at the front. The feedlot dirt pens contained 18,000 sq ft and also had fence-line bunks. About 60 head were allotted to each pasture or pen. During the 54-day study, cattle were treated when they appeared sick. The local veterinarian determined the choice of antibiotic therapy. The cost of mass medication was not included in the comparison of treatment drug costs.

Results and Discussion

Mass medication with injectable oxytetracycline hydrochloride at 2- to 3-day intervals did not improve ($P > .10$) the health or gain of newly received, highly stressed calves (Table 1). Indeed, mass medication reduced daily gain of calves in feedlot pens. The repeated stress of handling and injecting medicated calves may have influenced their performance compared to ungathered controls. Calves housed in grass paddocks had a lower incidence of sickness ($P < .01$) and fewer sick days per animal purchased ($P < .05$), resulting in fewer ($P < .05$) dollars spent on drugs. The reason for less sickness may be twofold. The calves in grass paddocks had more space to spread out and rest, which may have slowed the spread of respiratory disease. This may have allowed

calves time to develop some protection due to arrival vaccinations. However, perhaps more importantly, the calves in grass paddocks had a drier place to lie down with good wind protection during the wet winter weather.

Because the sick calves from both the drylot pens and grass paddocks were placed in the same sick pen, the observed reduction in sick days of calves from paddocks may have been attributable to their large size and shape. Calves that were reluctant to come to the feedbunk could be identified more easily, so sickness may have been detected earlier than in feedlot pens. The size of the grass paddocks also allowed sick cattle to move off by themselves, another early sign of illness. Because hay intake was not recorded and grass intake could not be measured, the effect of housing and mass medication on total feed intake was not determined.

Although responses in this study were measured using light-weight calves, it is likely that using grass paddocks also would reduce sickness in larger calves. However, there appear to be two keys for successful use of grass paddocks for receiving cattle. First, newly weaned calves should spend 2 to 4 days in tight pens to allow them to settle down and to reduce fence walking. Secondly, the design of the grass paddocks should be such that sick calves can be readily identified and easily sorted off for treatment with minimal stress.

Table 1. Effect of Mass Medication on the Health and Gain of Stressed Calves Housed in either Grass Paddocks or Feedlot Pens

Item	Grass Paddocks		Feedlot Pens	
	Control	Mass Medicated	Control	Mass Medicated
Daily gain, lb (54 day period)	1.80 ^a	1.74 ^a	1.74 ^a	1.50 ^b
Health criteria:				
Morbidity, %	35.30 ^d	27.20 ^d	50.30 ^c	51.80 ^c
Mortality, %	4.20	1.40	2.00	3.40
Medication cost, \$/head	5.91 ^b	5.01 ^b	12.05 ^a	9.80 ^a
Sick days/animal purchased	2.18 ^b	1.83 ^b	4.45 ^a	3.51 ^a

^{ab}Means in the same row with unlike superscripts are different ($P < .05$).

^{cd}Means in the same row with unlike superscripts are different ($P < .01$).

MANAGEMENT OF STABLE FLIES IN CATTLE FEEDLOTS WITH RELEASES OF PARASITIC WASPS

G. L. Greene and J. E. Cilek¹

Summary

During 1992, adult stable fly populations were sampled in 25 Kansas feedlots. A native stable fly parasitic wasp, *Spalangia nigroaenea*, was released in 19 of these feedlots. Stable fly populations were reduced up to 48% and parasite emergence was increased 21% when compared with feedlots where *S. nigroaenea* was not released. The percentage of total parasites that were *S. nigroaenea* nearly doubled in the release feedlots, compared to the nonrelease feedlots. This parasitic wasp has shown considerable promise for stable fly control in cattle feedlots. Overall, sampling and parasite costs averaged 32 cents per animal for the season.

(Key Words: Stable Fly, Pteromalidae, *Spalangia nigroaenea*, Cattle Feedlots, Fly Management.)

Introduction

Certain species of wasps lay their eggs in fly pupae. That kills the fly pupae and allows reproduction of the parasitic wasps. The use of these fly parasites to reduce stable flies in cattle feedlots has been a common practice in Kansas. How beneficial are these parasitic wasp releases? To answer that question, we previously sampled over a dozen feedlots where commercial parasites were released and found *S. nigroaenea* to be the major species retrieved from stable fly pupae regardless of the species being released. From 1987 to 1991, six season-long releases were made in feedlots using *S. nigroaenea*. As a result, the

number of stable flies was reduced, whereas the percentage of fly pupae producing parasites increased. With those promising results, a large-scale demonstration-research project was conducted in 1992. The objective of this study was to determine the effectiveness of the wasp, *S. nigroaenea*, in various feedlot environments before recommending it as a stable fly control measure. Additional objectives were to develop an economical, integrated pest management system for stable fly reduction, develop a fly population estimation system, and establish a better basis for parasite release numbers. The 1992 results for fly reduction, parasite increase, and the economics of parasite release and sampling are presented.

Experimental Procedures

There were 25 cooperating Kansas cattle feedlots in this study during 1992. Adult stable fly populations were sampled with four Alsynite sticky traps placed at the margins of each feedlot, except for larger yards where up to eight traps were used. Each week, the number of stable flies trapped was recorded, and the sticky covering on the Alsynite traps was replaced. Samples of naturally occurring stable fly pupae were collected weekly from each feedlot and held in the laboratory to determine the species and number of emerging flies and parasitic wasps.

Generally, *S. nigroaenea* was released weekly at 19 feedlots from the middle of May through the end of September. Parasite emergence from the 19 release lots was compared with that from six nonrelease lots, of

¹Southwest Kansas Research-Extension Center, Garden City, KS.

which three used commercial parasite releases and three had no releases. Stable fly pupae emergence records were kept from all releases on each of the 19 lots. Such records were not kept on the three lots where commercial releases occurred, because we were not privileged to the parasite species, emergence rate, or parasite release rate.

Data from the feedlots were divided according to the number of stable flies collected from Alsynite traps. Feedlots that fit the low fly population category generally had good manure sanitation with regular pen cleaning and did not stockpile manure on their premises. Feedlots that fit the high stable fly population category generally had poor sanitation, did not clean pens regularly, and usually stockpiled wet manure on their premises. Feedlots that were in the moderate category generally practiced sanitation between these two extremes.

Results and Discussion

The cool, wet conditions during the summer of 1992 resulted in more stable flies than previous years. Their continued presence from June into September had not been witnessed before, and the irritation to cattle was greater than previously observed. In feedlots with low stable fly populations (Table 1), local precipitation patterns and physical characteristics of the feedlots, in addition to the parasitic wasp releases, helped to further reduce stable flies. Some of these feedlots were along the western border of Kansas where conditions were drier, whereas other feedlots were built with excellent slopes and good drainage. Fly reduction in the release lots averaged about 47% compared with nonrelease lots in the low stable fly category.

The feedlots with medium fly level contained several conditions attractive for stable fly development. Although some lots were relatively clean, they generally had one major fly breeding area. For example, runoff areas that accumulated manure in or around the perimeter were found to breed an excessive number of stable flies. Other lots had stockpiled wet manure or had manure in pens or along fencelines and water standing in pens, a

breeding situation that produced millions of stable flies! Fly reduction on these release lots averaged 42% compared with nonrelease lots.

Feedlots with high numbers of stable flies all had manure piled on the premises, in addition to the excellent fly breeding conditions found in the medium fly level feedlots. These breeding areas produced stable flies all summer. Some of these feedlots still had to apply insecticides to reduce stable flies because they were producing more flies than economical releases of parasites could handle. Fly reduction on these release lots averaged 35% compared to nonrelease lots.

In most cases, the number of stable flies in the parasitic wasp release lots was a third to one-half lower than that in nonrelease lots. In fact, one feedlot discontinued parasite releases in early July, and the stable fly population increased to above the nonrelease feedlot level 10 days later, demonstrating that parasite releases had provided effective control.

Parasitism levels of stable fly pupae in the release feedlots were about double those in the commercial or nonrelease feedlots (Table 2). The percent parasitism in the non-release feedlots was about half that recorded during previous years, perhaps as a result of higher stable fly populations during 1992. Of the total parasite emergence in the 19 release lots, the number of *S. nigroaenea* was nearly double that in the nonrelease feedlots and 14.3% more than that in the commercial release feedlots.

Just as sanitation level influenced stable fly abundance, it also affected the quantity and cost of parasite releases. The cost of sampling and parasites per animal varied from \$.09 to \$1.34 among feedlots, a 15-fold difference. Feedlots with low fly populations had average costs of \$0.37 per head for the season (Table 1). Costs for feedlots with medium fly levels averaged \$0.24 per animal, whereas those for feedlots with high fly populations averaged \$0.54 per animal for the season. The medium group of feedlots had a lower cost per head because of larger cattle numbers per feedlot. Overall, sampling and parasite costs for the 19 feedlots in the study averaged \$0.32 per head for 1992.

Table 1. Costs of Cattle Feedlot Stable Fly Management with Parasites in 1992

Fly level	No. of feedlots	No. of cattle/lot (1000's)	Cost, \$ per head		
			Parasites	Sampling	Total
Low (49-53) ^a	5 (.27 to .52)	9.64 (2.2 to 22)	.26	.11	.37
Med (107-138)	9 (.09 to 1.15)	36.93 (4.5 to 100)	.1.8	.06	.24
High (184-253)	5	22.20 (7 to 37)	.42	.12	.54 (.32 to 1.34)

Average		25.88	.24	.08	.32

^aNumbers in parentheses are the ranges from low to high.

Table 2. Stable Fly Pupal Parasite Collections from Cattle Feedlots in Southwest Kansas during 1992

Feedlot Group	Stable Fly Pupae % Emergence	
	Total Parasites ^a	<i>S. nigroaenea</i> ^b
Low Fly	50.7	80.5
Med. Fly	35.8	72.2
High Fly	38.9	71.7
Average	39.0	73.9
Commercial	21.9	59.6
Non-release	18.2	38.6

^a100 minus these numbers = percentage of live fly emergence.

^b100 minus these numbers = percentage of all other parasite species emerging.

BIOLOGICAL VARIABILITY AND STATISTICAL EVALUATION OF DATA

The variability among individual animals in an experiment leads to problems in interpreting the results. Animals on treatment X may have a higher average daily gain than those on treatment Y, but variability within the groups may indicate that the difference between X and Y is not the result of the treatment alone. You can never be totally sure that the difference you observe is due to the treatment, but statistical analysis lets researchers calculate the probability that such differences are from chance rather than from the treatment.

In some articles, you will see the notation " $P < .05$." That means the probability that the observed difference was due to chance is less than 5%. If two averages are said to be "significantly different," the probability is less than 5% that the difference is due to chance — the probability exceeds 95% that the difference is true and was caused by the treatment.

Some papers report correlations — measures of the relationship between traits. The relationship may be positive (both traits tend to get larger or smaller together) or negative (as one gets larger, the other gets smaller). A perfect correlation is either +1 or -1. If there is no relationship at all, the correlation is zero.

You may see an average given as $2.5 \pm .1$. The 2.5 is the average; .1 is the "standard error." That means there is a 68% probability that the "true" mean (based on an unlimited number of animals) will be between 2.4 and 2.6. "Standard deviation" is a measure of variability in a set of data. One standard deviation on each side of the mean is expected to contain 68% of the observations.

Many animals per treatment, replicating treatments several times, and using uniform animals all increase the probability of finding real differences when they actually exist. Statistical analysis allows more valid interpretation of the results, regardless of the number of animals in an experiment. In the research reported herein, statistical analyses are included to increase the confidence you can place in the results.

In most experiments, the statistical analysis is too complex to present in the space available. Contact the authors if you need further statistical information.

WEATHER DATA, 1991-1992

On the following page are graphs of the 1991 and 1992 Manhattan weather. They were produced by the Kansas Agricultural Experiment Station Weather Data Library. The smooth line that starts in the lower left corner of each graph is the normal accumulated precipitation since January 1. The rough line starting in the lower left corner represents actual accumulated precipitation. A long horizontal section of that line represents time during which no precipitation fell. A vertical section represents precipitation. The other two smooth lines represent average daily high and low temperatures, and the rough lines represent actual highs and lows.

These graphs are included because much of the data in this publication, especially data on animal maintenance requirements and forage yields, can be influenced by weather. Weather graphs have been included in Cattlemen's Day publications for the past eight years.

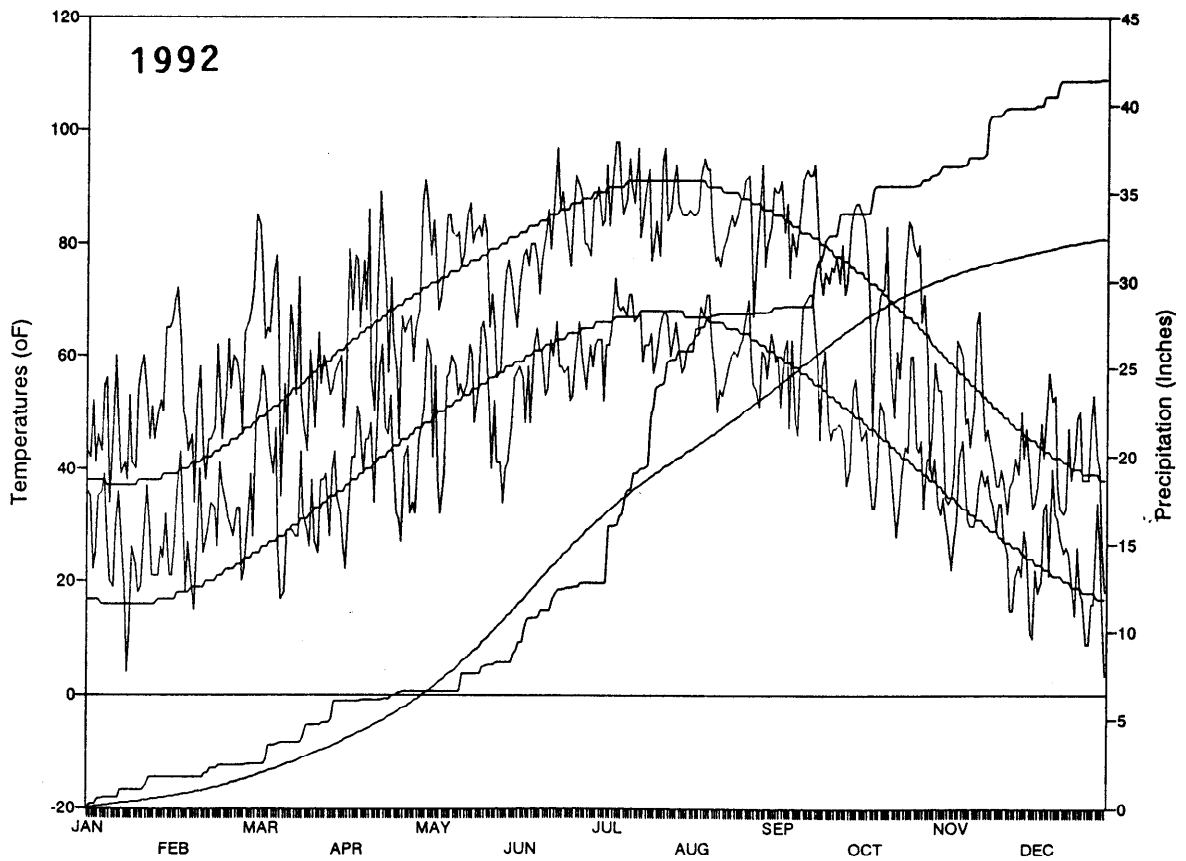
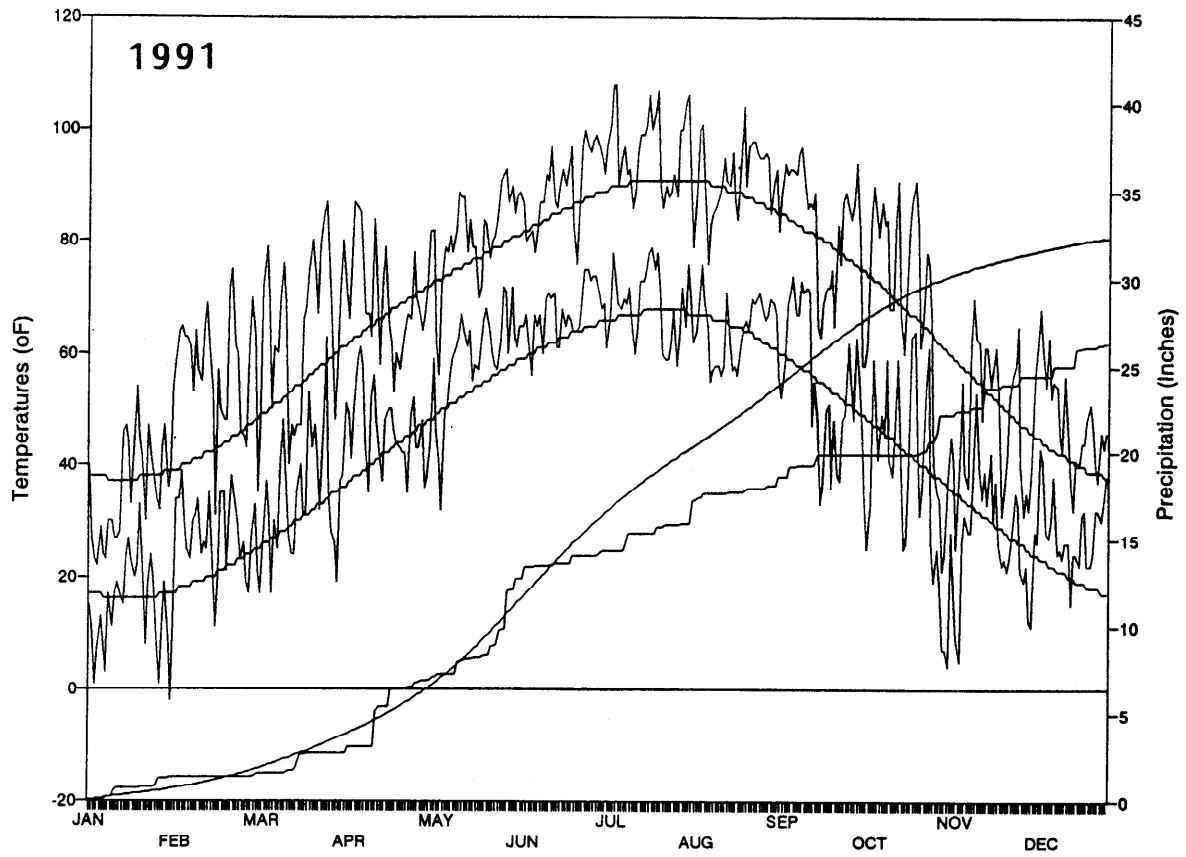

ACKNOWLEDGEMENTS

Listed below are individuals, organizations, and firms that have contributed to this year's beef research program through financial support, product donations, or services. We appreciate your help!

A.C. Legg, Inc., Birmingham, Alabama
David Allison, Riley, Kansas
Alltech, Inc., Nicholasville, Kentucky
American Alfalfa Processors Association,
Overland Park, Kansas
Barton County Feeders, Inc., Ellinwood,
Kansas
Bert and Wetta, Abilene, Kansas
Biotol, Inc., Eden Prairie, Minnesota
Biozyme Enterprises, Inc., St. Joseph,
Missouri
Brinks Brangus Ranch, Eureka, Kansas
Brookover Feed Yards, Inc., Garden City,
Kansas
Brookover Ranch Feed Yard, Inc., Garden
City, Kansas
Caprock Industries, Inc., Leoti, Kansas
Cargill Hybrid Seeds, Minneapolis, Minnesota
Chr. Hansen's Bio Systems, Milwaukee,
Wisconsin
Church and Dwight Co., Princeton, New
Jersey
Circle E Feedlot, Potwin, Kansas
Steve Clark, Havana, Kansas
Jim Colborn, Medicine Lodge, Kansas
Mike Collinge, Hamilton, Kansas
Cumberland Packing Co., Inc., Racine,
Wisconsin
Dick Darley, San Diego, California
DuPont & Company, Inc., Newark, Delaware
Elanco Products Co., Indianapolis, Indiana
Excel Corporation, Dodge City, Kansas
Farmland Industries, Inc., Kansas City,
Missouri
Five N Feeders, Inc., Johnson, Kansas
Floyd Cattle Co., Inc., Johnson, Kansas
Grant County Feeders, Ulysses, Kansas
Great Lakes Biochemical Co., Inc.,
Milwaukee, Wisconsin
Jack and Alan Grothusen, Ellsworth, Kansas
Bill Haw, Kansas City, Missouri
Hay Forage Industries, Hesston, Kansas
Hitch Feeders II, Garden City, Kansas
Hoechst-Roussel Agri-Vet, Inc., Somerville,
New Jersey
Hoffmann-LaRoche, Inc., Nutley, New Jersey
IBP, Emporia and Finney County, Kansas
ICI Seeds, West Des Moines, Iowa
Ingalls Feed Yard, Ingalls, Kansas
International Bakerage of Kansas, Inc., Kansas
City, Kansas
International Brangus Breeders Association,
Inc., San Antonio, Texas
International Silo Association, Lenexa, Kansas
Ivy Laboratories, Overland Park, Kansas
Jack Janssen, Geneseo, Kansas
John Deere, Inc., Ottumwa, Iowa
Gary Johnson, Dwight, Kansas
Kansas Farm Management Association,
Manhattan, Kansas
Kansas Racing Commission, Topeka, Kansas
Kemin Industries, Inc., Des Moines, Iowa
Knight Feedlot, Inc., Lyons, Kansas
Lane County Feeders, Inc., Dighton, Kansas
Livestock and Meat Industry Council, Inc.
(LMIC), Manhattan, Kansas
Lynch Feed Yard, Inc., Dodge City, Kansas
Micro-Chemical Co., Amarillo, Texas
Montezuma Feeders, Inc., Montezuma, Kansas
MSD AgVet, Rahway, New Jersey
National By-Products, Garden City, Kansas
National Farms, Inc., Kansas City, Missouri
NBI, Manhattan, Kansas
NutriBasics, Willmar, Minnesota
Pawnee Valley Feeders, Inc., Hanston, Kansas
Perrier Feed Yard, Dodge City, Kansas
Pfizer, Inc., Lees Summit, Missouri
Peterson Laboratories, Hutchinson, Kansas
Pioneer Hi-Bred International, Inc., Genetics
Division, West Des Moines, Iowa
Pioneer Hi-Bred International, Inc., North
American Seed Division, Johnston, Iowa
Pitman-Moore, Inc., Mundelein, Illinois
Plunkett Feedlot, Syracuse, Kansas
Porter Farms, Reading, Kansas
Pratt Feeders, Ashland, Kansas
Reeve Cattle Co., Garden City, Kansas
Rex Stanley Feed Yard, Inc., Dodge City,
Kansas
Royal Beef, Scott City, Kansas
S-Bar Ranch Feedlot, Sublette, Kansas
Select Sires, Inc., Plain City, Ohio
Servi-Tech, Inc., Dodge City, Kansas

Smith Kline Beecham Animal Health, West
Chester, Pennsylvania
Southeastern Poultry and Egg Association,
Decatur, Georgia
Sublette Feeders, Sublette, Kansas
Sunglo Feeds, Inc., Hesston, Kansas
Syntex Animal Health, Inc., Des Moines, Iowa
Tastemaker, Cincinnati, Ohio
The J.C. Robinson Seed Co., Waterloo,
Nebraska

The Upjohn Company, Kalamazoo, Michigan
USDA, Washington, DC
Ward Feed Yard, Larned, Kansas
Warner Ranches, Cimarron, Kansas
Winger Feedyard, Inc., Johnson, Kansas
Albert Wiggins, Eureka, Kansas
W-W Livestock Systems, Dodge City, Kansas
Paul Zimmer, Shawnee Mission, Kansas
Zinpro Corp., Edina, Minnesota

Special thanks to Valerie Stillwell,
who prepared the camera ready copy.

Notice

Kansas State University makes no endorsements, expressed or implied, of any commercial product. Trade names are used in this publication only to assure clarity of communication.

Some of the research reported here was carried out under special FDA clearances that apply only to investigational uses at approved research institutions. Materials that require FDA clearances may be used in the field only at levels and for the uses specified in that clearance.



Agricultural Experiment Station, Kansas State University, Manhattan, 66506-4008

Report of Progress 678

March 1993

Kansas State University is committed to a policy of nondiscrimination on the basis of race, sex, national origin, disability, religion, age, sexual orientation, or other nonmerit reasons, in admissions, educational programs or activities, and employment, all as required by applicable laws and regulations. Responsibility for coordination of compliance efforts and receipt of inquiries, including those concerning Title IX of the Education Amendments of 1972 and Section 504 of the Rehabilitation Act of 1973, has been delegated to Jane D. Rowlett, Ph.D., Director, Affirmative Action Office, 214 Anderson Hall, Kansas State University, Manhattan, Kansas 66506-0104, (913/532-6220).